

MINOLTA

MAXXUM[®]
DYNAX[™]

3xi

☐ INSTRUCTION MANUAL

TABLE OF CONTENTS

Names of Parts and Displays — Body	4
Data Panel	6
Viewfinder	7

PREPARATIONS

Preliminary — Neckstrap	9
Eyepiece and Accessory Shoe Cap	9
Lens — Attaching	10
Removing	11
Care of glass surfaces	11
Battery — Inserting	12
Battery-condition indicators	13
Battery performance	14
Cold-weather operation	14
Film — Automatic film-speed setting	15
Loading film	15
Automatic rewind	18
Manual start of rewind	18

OPERATIONS IN DETAIL

Auto Stand-by Zoom (ASZ)	29
Focusing Details — AF illuminator	30
Special focusing situations	31
Manual focus	32
Exposure Details — Exposure modes	33
Changing exposure modes	33
A: Aperture priority	34
S: Shutter priority	36
M: Manual exposure	38
Bulb: Long exposures	40
Flash Details — Manual fill-flash (P mode)	42
Flash cancel (P mode)	42
Flash in A, S, and M modes	43
Flash range	43
Wireless/remote off-camera flash control	44

SIMPLE OPERATION

Holding the Camera	20
Main Switch/Eye-Start	21
Taking Pictures	22
Focus Signals	23
Focus Lock	24
Flash Basics — Flash signals	25
Pre-flash	26
Self-Timer	27

APPENDIX

Lens Aperture and Depth of Field	49
Shutter Speed and Moving Subjects	51
Accessory Information	52
Troubleshooting	53
Care and Storage	54
Technical Details	56
Quick Reference Guide	59

NAMES OF PARTS AND DISPLAYS

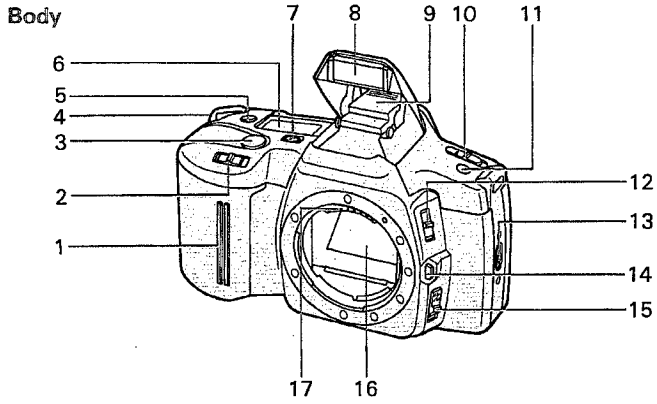

- | | |
|---|--|
| 1. Grip sensor
Activates eyepiece sensor | 8. Flash |
| 2. Shutter-setting control
Used to control shutter speed
is S and M modes and select
exposure mode | 9. Accessory shoe |
| 3. Shutter-release button | 10. Main switch |
| 4. Strap eyelet | 11. Self-timer button |
| 5. Pre-flash button
Selects/cancels pre-flash | 12. Aperture-setting control
Selects aperture in A and M
modes |
| 6. Data panel | 13. Back-cover release |
| 7. Program re-set button
Re-sets camera to
programmed operation | 14. Lens release |
| | 15. Focus-mode switch
Selects auto/manual focus |
| | 16. Mirror* |
| | 17. Lens contacts* |

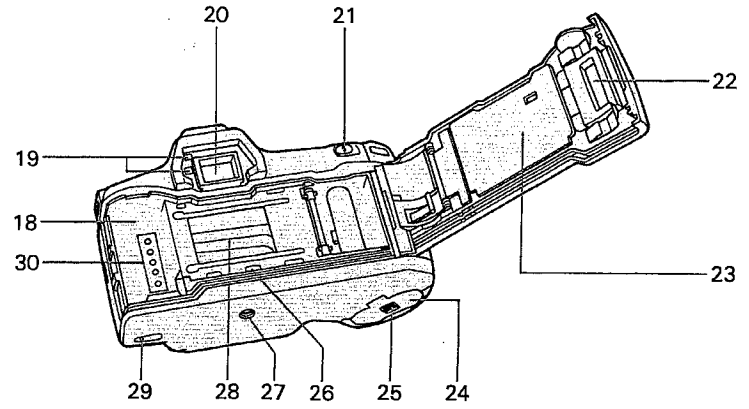

- | | |
|---|--|
| 18. Film chamber | 23. Pressure plate* |
| 19. Eyepiece sensor
IR sensor activates camera
when it detects an object
nearby | 24. Battery cover |
| 20. Viewfinder eyepiece* | 25. Battery-cover release |
| 21. Flash-control button
Used to pop-up built-in flash,
manually fire fill flash, and
cancel flash in P mode | 26. Guide rails |
| 22. Film window | 27. Tripod socket |
| | 28. Shutter* |
| | 29. Rewind button
Used to manually begin film
rewind |
| | 30. DX contacts* |

* Do not touch

(Names of parts and displays)

Data Panel

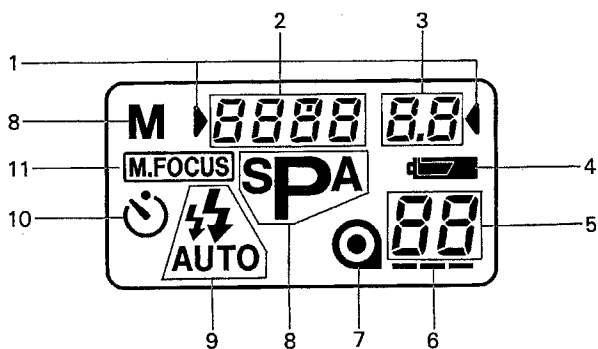

1. Selectable setting pointers
Indicates which settings are under manual control
2. Shutter-speed display
3. Aperture display
4. Battery-condition indicator
Displays level of battery charge
5. Frame counter
6. Film-transport signals
7. Film cartridge mark
Indicates film loaded, film rewound, film improperly loaded
8. Exposure-mode indicators
Indicates current exposure mode
9. Flash-mode indicators
Indicates current flash mode
10. Self-timer indicator
11. Manual-focus indicator

Viewfinder

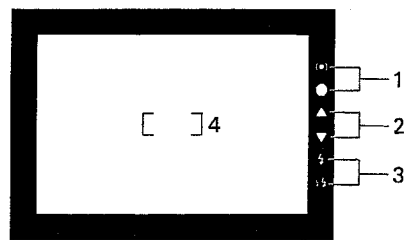

1. Focus signals
 - (●) Continuous AF mode: appears after Eye-Start when subject is in focus and after shutter-release button is pressed partway down if subject is moving
 - Focus locked: appears a short time after shutter-release button is pressed part way down if subject is stationary
 - (blinking) Focus cannot be confirmed
2. Exposure signals
 - In M mode:**
 - ▲ overexposure; ▼ underexposure; ◆ correct exposure
 - In P and A mode when flash is canceled:**
 - ▼ (blinking) Camera-shake warning: current shutter speed may result in blurry pictures
 - In all modes:**
 - ◆ (blinking) Correct exposure not possible
 - ▼ (blinking) Flash charging
3. Flash signals
 - ⚡ (blinking slowly) Flash charged
 - ⚡ (blinking rapidly) Flash output sufficient
4. Focus frame

PREPARATIONS

This section includes those things which you should do and understand before you use your camera. Read it thoroughly before you go on to **SIMPLE OPERATION** or **OPERATIONS IN DETAIL**.

PRELIMINARY

Neckstrap

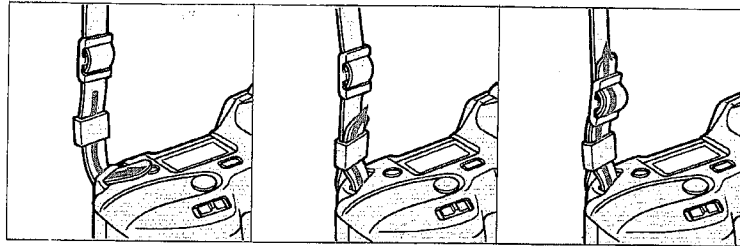

A neckstrap is supplied with your camera. Attach it as shown above.

Eyepiece and Accessory Shoe Cap

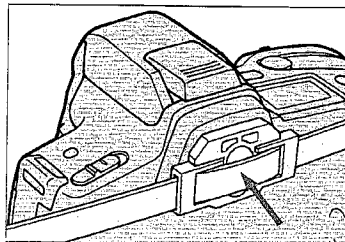

An eyepiece cap is attached to the strap. Fasten it to the viewfinder eyepiece whenever you use the self-timer or make long exposures. To attach the cap, snap it in place over the eyepiece as shown above; pull to remove.

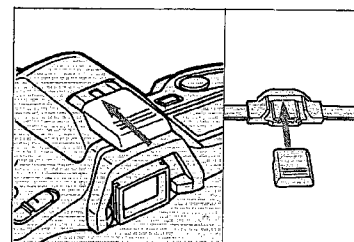

The camera also comes with an accessory shoe cap which protects the accessory-shoe contact. When you are using a flash or other accessory, slide the accessory shoe cap into the eyepiece cap for safekeeping.

LENS

Attaching

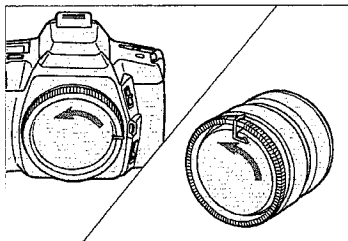

1. Turn the body cap and lens cap as shown and remove them.

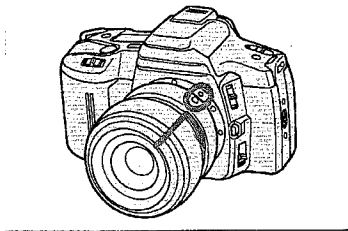

2. Align the red bead on the lens barrel with the red dot on the camera's lens mount. Fit the lens into the mount and turn the lens clockwise until it locks in place with a click.

Be careful...

- Do not force the lens if it does not turn smoothly.
- Never touch anything inside the camera, especially the lens contacts and mirror.

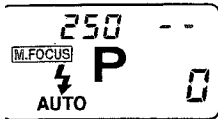

"--" will appear in the aperture display of the data panel if:

- No lens is attached to the camera
- The lens is not attached properly
- The AZ/MZ switch on an xi-Series lens is set to MZ

Removing

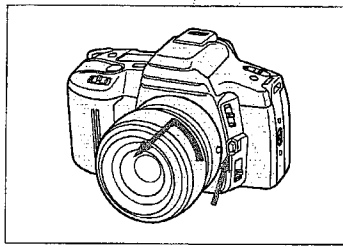

1. Press the lens release and hold it in while you turn the lens counter-clockwise until it stops. Lift the lens out of the mount.

2. Immediately attach the rear cap to the lens and the body cap or another lens to the camera. This will protect the lens elements, lens contacts, and camera interior.

Care of Glass Surfaces

- Never touch any lens surfaces (including the eyepiece) with your fingers. If a lens becomes dirty, first gently clean it with a lens brush. Then, if necessary, moisten a sheet of lens tissue with one drop of lens-cleaning fluid and, starting from the center of the lens, wipe the glass using a circular motion.
- Never lift the mirror or touch its surface. This may impair its alignment or scratch its face. Dust on the mirror's surface will not affect meter readings or picture quality. If it is distracting, have the camera cleaned at an authorized Minolta service facility.

BATTERY

This camera uses a 6-volt 2CR5 lithium battery to supply power to all of its operations. If you are also using an xi-Series lens, the camera battery also supplies power to the zoom motor built into the lens.

Inserting

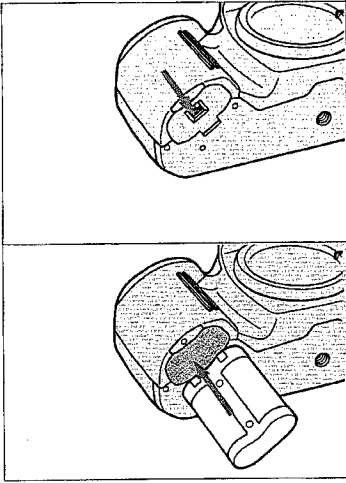

1. Move the main switch to **LOCK** and slide the battery cover release in the direction indicated to open the battery cover.

2. Insert the battery according to the marks on the inside of the chamber cover.

3. Snap the cover closed.

CAUTION

- Read and follow all warnings and instructions supplied by the battery manufacturer.
- Do not attempt to disassemble, recharge, or short-circuit the battery. Do not subject it to high temperatures or fire. The battery may explode and cause severe burns.
- Keep batteries away from small children.

Battery-condition Indicators

Whenever you move the main switch from **LOCK** to **ON**, one of the following indicators will appear in the data panel.

Indicator	Meaning
	1. Full-battery symbol appears for 4 sec. after you turn camera on—power is sufficient.
	2. Low-battery symbol appears for 4 sec. after you turn camera on—power is sufficient, but getting low. Keep a fresh battery handy.
	3. Low-battery symbol blinks while it appears with other operating indicators at any time during use—camera can be operated, but power is extremely low. The battery will need to be changed soon.
	4. Blinking low-battery symbol and bAtt appears, or no display appears at all, and shutter locks—power is insufficient for operation. Replace the battery or check that the battery is inserted correctly.

- Indicator 4 will appear even while the main switch is set to **LOCK**.

(Battery)

Battery Performance

The 6-volt 2CR5 lithium battery should provide sufficient power for shooting up to 60 rolls of 24-exposure film without flash. These figures are based on Minolta's standard test method using a fresh battery at 68°F (20°C). Actual performance will depend on how you use the camera. If you install a new battery that has been in prolonged storage, the camera's performance may vary.

Cold-Weather Operation

Lithium batteries perform well in cold weather. However, if you plan to shoot many rolls of film outdoors at temperatures near or below 32°F (0°C), we recommend that you carry the camera inside your coat to keep it warm while you are not shooting. You may also want to carry a spare battery in your pocket so that you can change the camera battery if necessary. Do not discard a cold battery. After it warms up, it will regain some of its charge.

FILM

Automatic Film Speed Setting

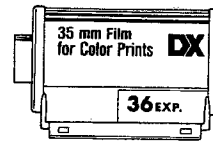

If you use DX-coded film between ISO 25 and 5000, the camera will automatically set the correct film speed. For flash photography, Minolta recommends that you use film between ISO 25 and 1000. If you use non-DX-coded film, the camera will automatically set ISO 100.

Loading Film

Before you load a roll of film, always check the data panel. If the film cartridge is displayed, **do not open the back cover**. Check the film window and frame counter to verify the type of film in the camera and the number of frames remaining. (See p.18 for instructions on rewinding an unfinished roll of film.)

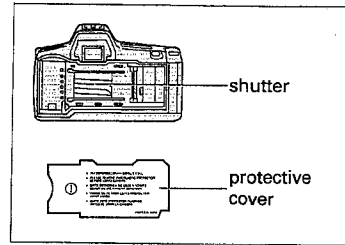

- Always load film in subdued light or shade.
- Before you load film for the first time, carefully remove and discard the protective plastic cover over the shutter.

— NEXT PAGE —

(Film)

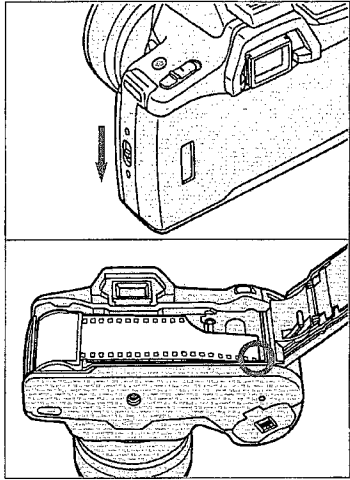

1. Open the back cover by sliding the back-cover release downward.

2. Place the film cartridge into the film chamber and extend the leader between the guide rails until the tip is just past the film-leader index.

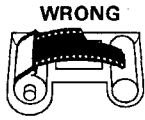
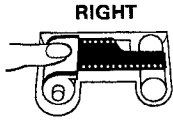

- **NEVER TOUCH THE SHUTTER CURTAIN WITH YOUR FINGERS OR WITH THE FILM TIP.** Its precision design makes it extremely sensitive to pressure.
- If the film leader is torn or crimped, it may not wind properly.
- If the film tip extends beyond the mark, gently push the excess back into the cartridge.

— NEXT PAGE —

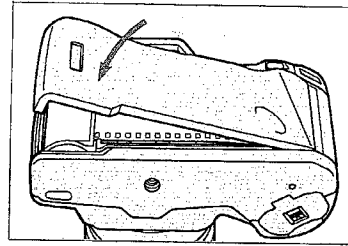

3. Close the back cover and move the main switch to **ON**. The camera will automatically advance the film to the first frame and 1 will appear in the film counter.

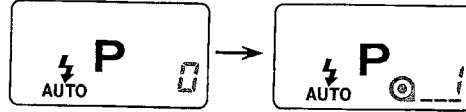

- If the film is loaded incorrectly, 0 will blink in the frame counter and the shutter will remain locked. Open the back cover and repeat steps 2 and 3.

- If you move the main switch to **ON** before you load film, do not touch the grip sensor during the above procedures because ASZ may activate.
- If you accidentally open the back cover before you rewind the film, quickly shut the back. The counter will reset to 1. Some of the pictures you have already taken will be ruined or will be discolored along the edges.

(Film)

Automatic Rewind

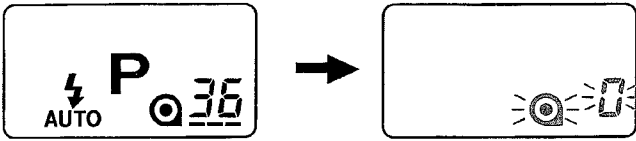

After you have exposed the last frame, the camera will automatically rewind the film. With a fresh battery, it takes about 18 sec. to rewind a 36-exposure roll, or 12 sec. for a 24-exposure roll.

When the film has been completely rewound, the motor will stop and the film-cartridge mark in the data panel will blink to indicate that it is safe to open the back cover.

Manual Start of Rewind

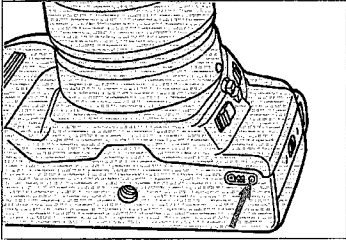

To begin rewind at any time, gently press the film rewind button on the bottom of the camera body.

- If the motor stops before the film is completely rewound, insert a fresh battery.

SIMPLE OPERATION — THE BASICS

This brief section is intended to help you get started using your new camera. It explains the simplest method of operation—with programmed autoexposure, autofocus, and autoflash. Details on each of the camera's functions begins on p.28 in the section entitled "Operation in Detail".

HOLDING THE CAMERA

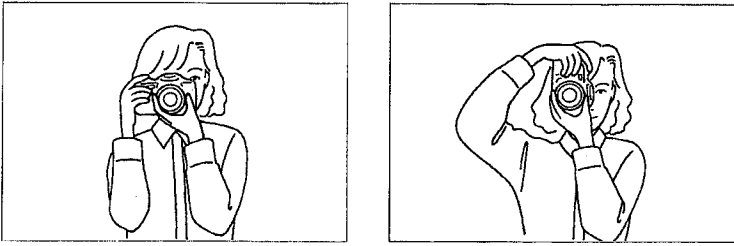

Hold the grip firmly in your right hand and use your left hand to support the camera or lens. Keep your elbows securely against your sides when shooting both horizontal and vertical pictures. Press the shutter-release button gently in a single, steady motion—never with a quick jab. Always keep the camera strap around your neck or wound around one wrist.

- When you pick up the camera, make sure you touch the grip sensor. Otherwise, Eye-Start will not function.
- Do not touch the focusing ring of an AF lens or the end of the lens barrel of an xi-Series Autozoom lens or AF Power Zoom lens.

MAIN SWITCH/EYESTART

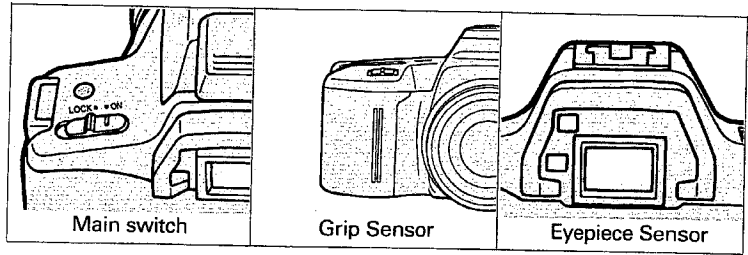

When you move the main switch to ON, the data panel and grip sensor activate. When you then touch the grip sensor, the eyepiece sensor is activated. This sensor then immediately activates autofocus and autoexposure when it detects an object near the viewfinder. If you are using an xi-Series Autozoom lens, auto stand-by zoom (ASZ) is also activated by Eye-Start and the lens will zoom automatically. By the time you frame your subject, therefore, the camera has performed many of its set-up operations and is ready to make an exposure. The eyepiece sensor also turns autofocus and autoexposure off 4 sec. after it no longer detects an object near the viewfinder.

- If you do not touch the grip sensor or if you are wearing gloves, you must activate autofocus and autoexposure by pressing the shutter-release button partway down. ASZ will not function in this case.
- If you are wearing sunglasses which absorb infrared light, Eye-Start may not function.

TAKING PICTURES

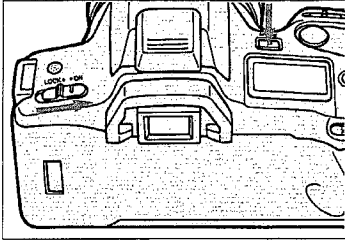

1. Slide the main switch to **ON**.
2. Press the program-reset button.

- Pressing the program-reset button sets the camera to programmed autoexposure mode, autofocus, and auto switchover flash.



3. Hold the camera as described on p. 20.
4. Place your main subject in the focus frame and press the shutter-release button down to take the picture.

After the exposure has been made, the camera will automatically advance the film to the next frame and will increase the film counter by one.

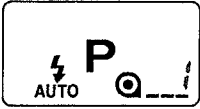

FOCUS SIGNALS

Signal	Meaning (notes below)
(●)	Continuous autofocus ¹
●	Focus is locked ¹
⇒●⇐(blinking)	Focus cannot be confirmed ²

1. After Eye-Start has activated the camera, the autofocus system will enter continuous AF mode and (●) will appear in the viewfinder when it has focused on your subject. When you press the shutter-release button partway down, your subject is stationary the camera will lock focus a short time later and will appear in the viewfinder. If your subject is moving, the camera will remain in continuous AF mode.

2. See p.31.

- This camera has Predictive AF. When you take a picture in continuous mode, the camera will calculate where the main subject will be when the shutter curtain actually begins to make the exposure, and it will set the lens to focus on this point before the mirror swings up. Extremely fast-moving subjects or subjects which are rapidly changing speed or direction, however, may exceed the capabilities of this system.

FOCUS LOCK



If, as a result of the composition or framing you have chosen, the main subject falls outside the main focus frame, first lock focus on your subject, then recompose the scene as desired.



1. Place your subject in the center of the AF area.

2. Press the shutter-release button partway down.



3. Wait for the focus signal to change from (●) to ●, recompose the picture, and press the shutter-release button all the way down to take the picture.

● Focus will not lock if your subject is moving.

Focus lock with the lens control ring:

If you are using an xi-Series or power zoom lens, you can lock focus by pulling the lens control ring towards the camera. Hold it in this position while you recompose and take the picture. Do not turn the ring after you lock focus.

FLASH BASICS

With programmed autoexposure (P mode), the camera begins measuring the brightness of your subject and the surrounding scene as soon as Eye-Star activates the camera. In P mode, the built-in flash will automatically pop-up when you press the shutter-release button partway down and fire whenever necessary.

● If you are using a lens hood, remove it before you take a photograph with the built-in flash.

Flash Signals

Viewfinder Signal	Meaning
▼ blinking	Flash charging
⚡ blinking slowly	Flash charged (pre-flash not selected)
⚡ blinking slowly	Flash charged (pre-flash selected)
⚡ blinking rapidly	Flash output sufficient (pre-flash not selected)*
⚡ blinking rapidly	Flash output sufficient (pre-flash selected)*

* This signal appears after you take the picture when the light supplied by the flash was enough to provide a correct exposure.

(Flash Basics)

Pre-Flash

In photos of people, sometimes the subject's eyes appear to glow bright red. This is caused by light from the flash reflecting off the interior of the person's eyes. This camera has a pre-flash feature which reduces the appearance of "red eye". In pre-flash mode when you press the shutter-release button completely down, the flash will fire a series of pulses before the main burst. This causes your subject's pupils to close slightly and greatly reduces the amount of light which will reflect off of the inside of their eyes.

To select pre-flash:

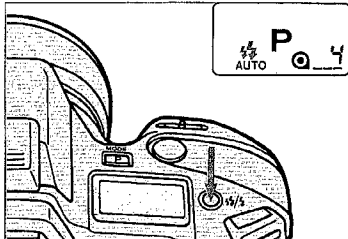

Press the pre-flash button once so that  AUTO appears in the data panel. The pre-flash will fire before every flash exposure.

To cancel pre-flash:

Press the pre-flash button again;  AUTO will appear in the data panel.

- Pressing the program re-set button will not cancel pre-flash.
- When you use pre-flash, warn your subject before you take the picture that the flash will fire several times so that they know what to expect.
- The built-in flash also acts as the camera's AF illuminator. Canceling pre-flash **will not** cancel the AF illuminator flash. See p.30 for details.

SELF-TIMER

The electronic self-timer will delay release of the shutter by about 10 sec. from the time you press the shutter-release button.

To activate the self-timer:

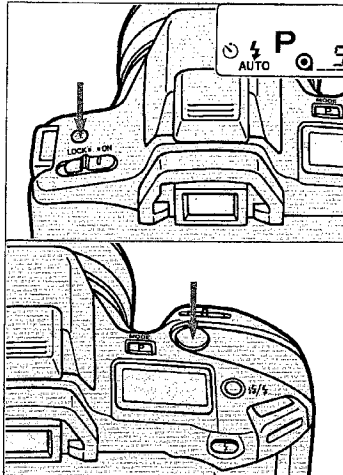

1. Press the self-timer button. The self-timer indicator will appear in the data panel.

- Press the self-timer button again to cancel.

2. Compose your scene and attach the eyepiece cap.

3. Press the shutter-release button.

- In P mode, unless you have cancelled the flash, three small bursts will fire just before the shutter releases. In A, S, and M modes, this will happen only if you first pop-up the flash. To cancel this self-timer announcement without cancelling normal flash operation, press and hold the pre-flash button down and move the main switch from **LOCK** to **ON**.
- If a dedicated accessory flash is attached, its AF illuminator will blink three times just before the shutter releases.
- To cancel the self-timer while it is operating, move the main switch to **LOCK**.
- The self-timer automatically switches off after shutter-release. To make another exposure with the self-timer, repeat steps 1-3.

OPERATIONS IN DETAIL

Once you have learned the basics of using your camera, this section will help you to take more control over its operation.

AUTO STAND-BY ZOOM (ASZ)

If you are using an xi-Series Autozoom lens, the camera's automatic control also extends to zooming the lens. Whenever Eye-Start activates the camera the lens immediately sets a programmed focal length based on the distance to your subject. This setting should provide a good starting-point in your composition.

- ASZ's operation is a one-shot function; it will not set a new focal length every time you point the camera at a new subject unless you first take the camera away from your eye. If you use power zoom to change ASZ's setting ASZ will not function again until you remove the camera from your eye and wait 20 sec.
- If the grip sensor does not activate Eye-Start, ASZ will not function. In this case, pressing the shutter-release button partway down will activate all of the camera's automatic systems except ASZ.

To cancel ASZ:

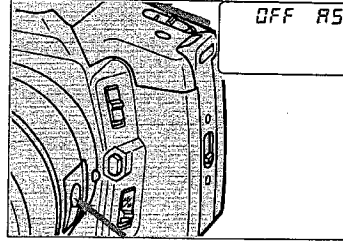

Press and hold the lens-function button on the lens barrel while you move the main switch from **LOCK** to **ON**. **OFF AS** will appear in the data panel.

- To turn ASZ on again, repeat the above step. **ON AS** will appear in the data panel.
- ASZ does not work if you are using an AF Power Zoom lens.
- No other autozoom functions are available when this camera is used with an xi-Series Autozoom lens.

FOCUSING DETAILS

AF Illuminator

When flash is required, if the AF system cannot detect a subject to focus, the built-in flash will automatically fire low-power bursts when you press the shutter-release button partway down. This provides focus-assist lighting for the AF system to operate normally even in complete darkness.

To cancel AF illuminator:

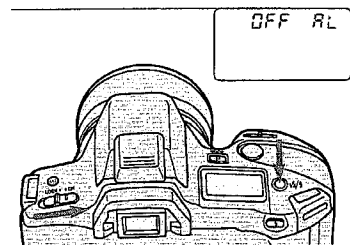

Press and hold the pre-flash button down while you move the main switch from **LOCK** to **ON**. **OFF AL** will appear in the data panel.

- To re-activate the AF illuminator, repeat the above procedure. **ON AL** will appear in the data panel.
- The AF illuminator will not work in P mode if the flash is not necessary or if you have canceled it, or in A, S, or M mode if the flash is down.
- Canceling pre-flash will not effect the AF illuminator.
- The range of the AF illuminator is approximately 3.3-16ft. (1-5m).

Special Focusing Situations

The camera's autofocus system will produce sharp pictures in almost every situation. In the cases described below, however, it may be difficult or impossible for the camera to autofocus properly—manual focusing may be necessary (see p.32).

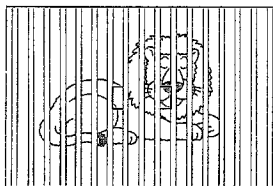

If two subjects at different distances overlap within the focusing frame

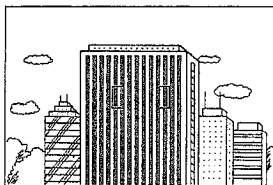

If a subject composed of alternating light and dark lines completely fills the focusing frame

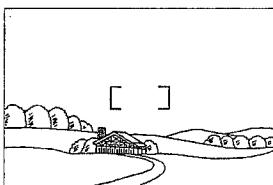

On very bright or low-contrast subjects

- You can also first lock focus on another object of equal distance and then recompose your picture (see p.24).

Manual Focus

To manually focus the lens:

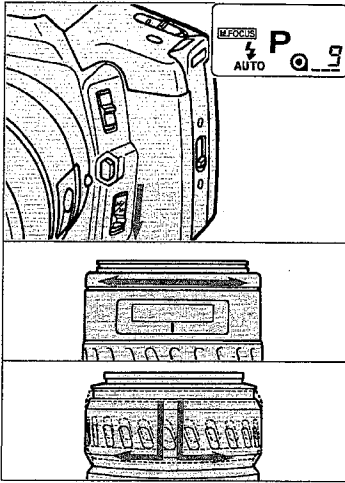

1. Slide the focus-mode switch down to set the camera to manual focus mode.
M. FOCUS will appear in the data panel.

2. If you are using an AF lens, turn the focusing ring until the subject appears sharp. With an xi-Series lens or AF power zoom lens, pull and turn the control ring. For more information, refer to the lens manual.

- When your subject comes into focus, ● will light in the viewfinder.
- To return to autofocus mode, slide the focus-mode switch down.
- Pressing the program re-set button will also return the camera to autofocus mode, and will also change all of the programmable functions to their default settings.
- In manual focus mode, the shutter will release even if the subject is not in focus.

EXPOSURE DETAILS

Exposure Modes

The camera has four exposure modes: programmed autoexposure (P), aperture-priority autoexposure (A), shutter-priority autoexposure (S), and manual exposure (M). In P mode, Expert Program Selection automatically evaluates such factors as subject distance, brightness, and movement as well as focal length before it sets aperture and shutter speed. It will then optimize the exposure settings based on the particular requirements of the situation at hand. There is no single program line for each focal length, and no special modes to set manually for different situations.

Changing Exposure Mode

If you want more creative control over the camera's exposure settings, use A, S, or M mode. Each mode is explained in following sections.

To change exposure mode:

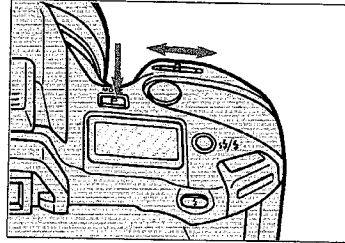

1. Press and hold the program re-set button as you move the shutter-setting control.
2. When you release the program re-set button, the mode you have selected will be entered automatically.

- To return to P mode, press the program re-set button.

(Exposure Details)

A: Aperture-Priority

In A mode, you set the aperture you want and, the camera will automatically set the shutter speed to maintain a correct exposure.

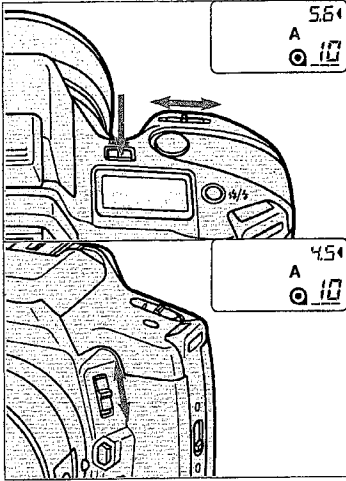

1. Refer to p.33 (Changing Exposure Mode) and select **A**. A pointer will appear next to the aperture display.

2. To set the aperture, slide the aperture-setting control up or down. The aperture display in the data panel will change in 1/2-stop increments.

- Available apertures are limited to those within the range indicated on the lens you are using.

Data Panel and Viewfinder Exposure Signals

Data Panel	Viewfinder	Meaning
		Faster shutter speed not available. Over exposure will result. Set a smaller aperture, reduce light level, or use slower film.
		Slower shutter speed not available. Under exposure will result. Set a larger aperture, increase light level, or use faster film.
		Light level is beyond the coupling range of the camera and lens. Reduce bright light or increase low light.
		Flash is canceled and the shutter speed too slow to allow sharp, hand-held photographs. Set a larger aperture, activate the flash, or mount the camera on a tripod.

[Exposure Details]

S: Shutter-Priority

In S mode, you select the shutter speed you want and, if the lens you are using allows, the camera will automatically set the correct aperture to ensure a proper exposure.

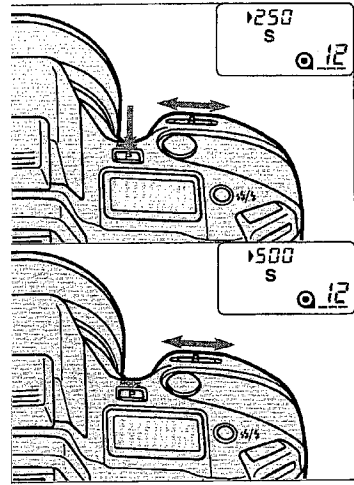

1. Refer to p.33 (Changing Exposure Mode) and select **S**. A pointer will appear next to the shutter speed display.

2. To set the shutter speed, move the shutter-setting control to the left or right. The shutter speed display in the data panel will change in 1-stop increments.

• You cannot select BULB in S mode.

Data Panel and Viewfinder Exposure Signals

Data Panel	Viewfinder	Meaning
<p>Largest f/# blinks*</p>		<p>Smaller aperture not available. Over exposure will result. Set a faster shutter speed, use slower film, or reduce light level.</p>
<p>Smallest f/# blinks*</p>		<p>Larger aperture not available. Under exposure will result. Set a slower shutter speed, use faster film, or increase light level.</p>
		<p>Light level is beyond the coupling range of the camera and lens. Reduce bright light or increase low light.</p>

* The largest and smallest f/# depend on the specifications of the lens you are using.

(Exposure Details)

M: Manual Exposure

In manual mode, you have full control over the exposure settings. In this mode, you select the shutter speed and aperture and the camera will tell you whether your settings will provide an over-, under-, or correctly- exposed picture.

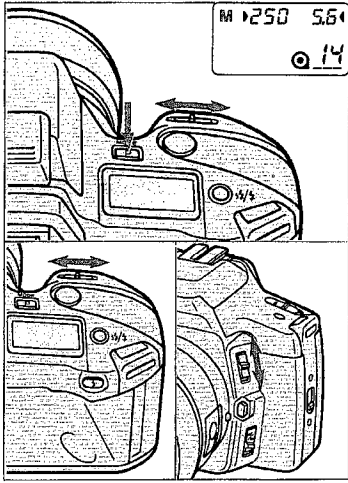

1. Refer to p.33 (Changing Exposure Mode) and select **M**. Pointers will appear next to both the shutter speed and aperture displays.

2. To set the shutter speed, move the shutter-setting control to the right or left. To set the aperture, move the aperture-setting control up or down.

- The shutter speed will change in 1-stop increments and the aperture will change in 1/2-stop increments.

Viewfinder Exposure Signals

Viewfinder signal	Meaning
⬆	Exposure is correct.
⬆	Over-exposure will result.
⬇	Under-exposure will result.
⬆⬇ (blinking)	Light level is beyond the coupling range of the camera and lens.

(Exposure Details)

BULB: Long Exposures

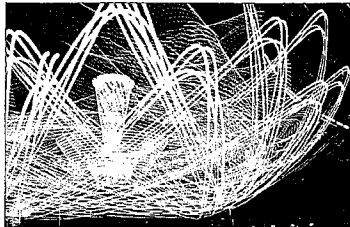

When you select **BULB**, the shutter will remain open as long as you press the shutter-release button.

To use BULB setting:

1. Mount the camera on a tripod.
2. Set the exposure mode to M (manual).
3. Slide the shutter-setting control to the left until **bulb** appears in the data panel. Use the aperture-setting control to select the aperture.
4. Compose your scene and focus the lens.

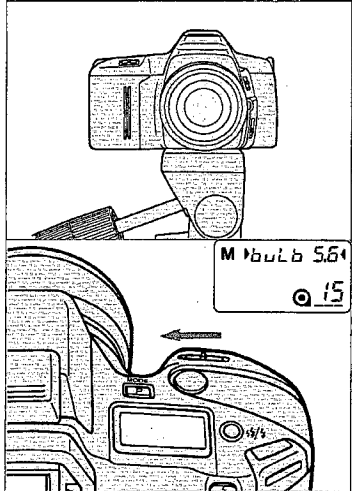

- If the scene is too dark, autofocus may not function. Slide the focus mode switch down and focus the lens manually.

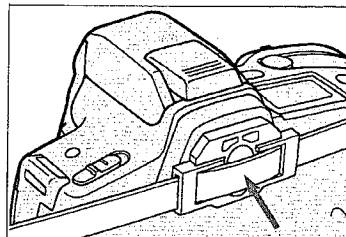

5. Attach the eyepiece cap to prevent stray light from entering the camera and affecting the exposure.

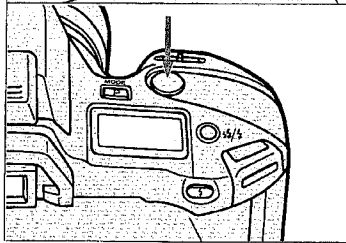

6. To take the picture, press the shutter-release button and hold it down for the duration of the exposure. The shutter will remain open as long as you hold the shutter-release button down.

— NEXT PAGE —

FLASH DETAILS

Manual Fill-Flash (P Mode)

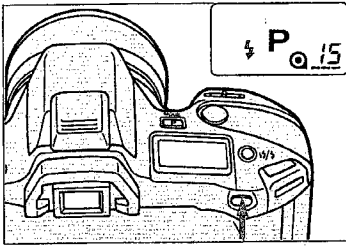

In P mode, the built-in or an attached, dedicated flash will fire whenever necessary. To fire the flash manually in P mode regardless of lighting conditions, press and hold the flash-control button while you take the picture.

Flash Cancel (P Mode)

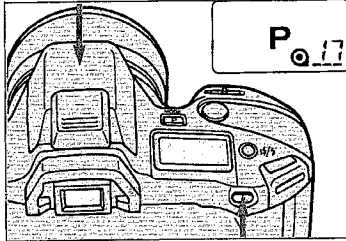

To prevent the built-in flash from firing in P mode:
Press and hold the flash-control button while you press the flash down.

- The flash-mode indicator in the data panel will disappear.
- To restore autoflash operation, press the program re-set button or press flash-control button again.
- If you have canceled the flash and the shutter speed is too slow to allow sharp pictures while hand-holding the camera, the camera-shake warning (▼) will blink in the viewfinder. Mount the camera on a tripod or activate the flash. In S or M mode, the camera-shake warning will not function.

Flash in A, S, and M Modes

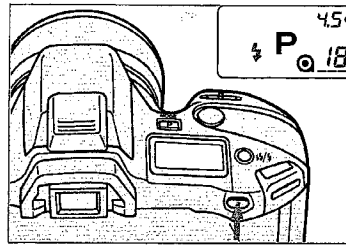

In A, S, and M modes, when the built-in flash is up it will fire every time you take a picture. When it is down it will not fire. To activate the built-in flash in these exposure modes, press the flash-control button. To cancel the flash, push it down until it locks in place.

- Similarly, if a dedicated accessory flash is attached to the camera and turned on, it will fire every time you take a picture and will not fire when it is turned off.

Exposure mode	Available shutter speeds when flash activated
A	1/90 sec. (set automatically)
S	1/90 - 30 sec. (set automatically)
M	1/90 - 30 sec. and BULB (set manually)

Flash Range

The range of the built-in flash is shown below.

Keep your subject within the range indicated for the aperture you are using.

Aperture	ISO 100	ISO 400
1.4	3.3-28ft./1.0-8.4m	3.3-56ft./1.0-17m
2	3.3-20ft./1.0-6.0m	3.3-39ft./1.0-12m
2.8	3.3-14ft./1.0-4.2m	3.3-28ft./1.0-8.4m
4	3.3-9.8ft./1.0-3.0m	3.3-20ft./1.0-6.0m
5.6	3.3-7.0ft./1.0-2.0m	3.3-14ft./1.0-4.2m
8	3.3-4.9ft./1.0-1.5m	3.3-9.8ft./1.0-3.0m
11	3.3ft./1.0m	3.3-6.6ft./1.0-2.0m

(Flash Details)

Wireless/Remote Off-Camera Flash Control

When used with the 3500xi flash unit, this camera offers you the flexibility of wireless/remote, off-camera flash control with TTL flash metering. Because the signal that fires the off-camera flash is a small burst from the built-in flash, reduce the brightness of your surroundings as much as possible when you are using this feature.



Flash 3500xi

With off-camera flash

Without off-camera flash

To take pictures with off-camera flash:

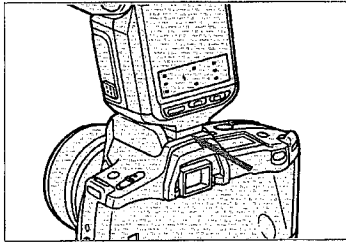

1. Set the channel selector switch inside the flash battery chamber to **CH1**. Attach the flash to the camera and press the flash's ON/OFF button to turn it on.

— NEXT PAGE —

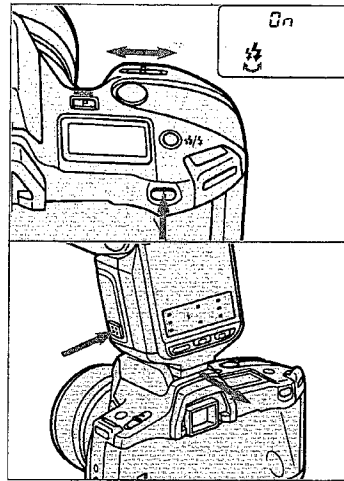

2. Press and hold the camera's flash-control button and move the shutter-setting control to select wireless/remote flash mode. **Fn** will appear in the data panel and the flash icon will blink alternately.

3. Remove the flash and position it according to the diagram below and the table on p. 47. Make sure the flash's AF illuminator is pointing at the subject.

- The off-camera flash may not detect the control signals if it is placed behind the subject.

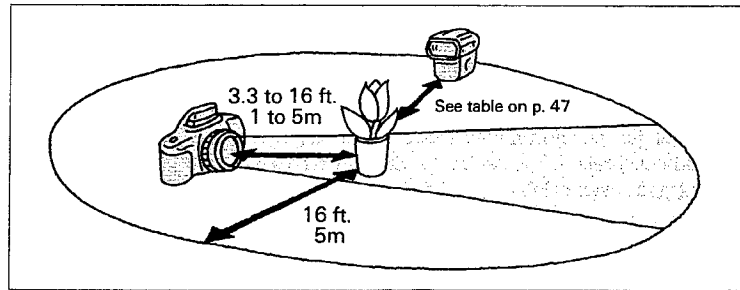

— NEXT PAGE —

(Flash Details)

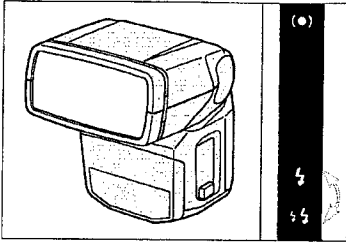

4. Wait until both the off-camera flash and built-in flash are charged.

- In wireless/remote mode, the off-camera flash's AF illuminator and the flash-ready indicator will blink when it is charged. Both flash signals in the viewfinder will blink alternately when the built-in flash is charged.

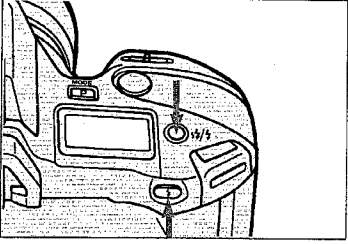

5. Press the flash-control button to pop-up the built-in flash. Press the pre-flash button to test-fire the off-camera flash and wait again until both flashes are fully charged.

6. Take the picture.

- The off-camera flash will not automatically zoom. You must manually select the setting which matches your lens setting. Refer to the flash manual for details.
- In all exposure modes, when the camera is set to wireless/remote flash mode, the built-in flash will fire the control signal every time you press the shutter-release button.
- In M mode, you cannot select shutter speeds faster than 1/45 sec.
- To cancel wireless/remote mode, press the program re-set button or repeat step #2 and select **OFF**.

Ratio Control

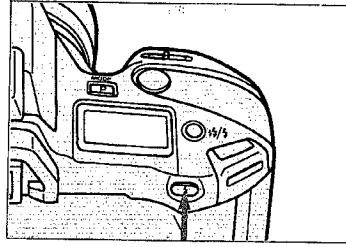

In wireless/remote mode, you can use the off-camera flash and built-in flash to provide a 2:1 lighting ratio on your subject. Simply press the flash control button and hold it while you take the picture. The off-camera flash will provide 2/3 of the exposure and the built-in will add the remaining 1/3.

Wireless/Remote Flash Range

Aperture	ISO 100	ISO 400
1.4	6.6-16ft./2.0-5.0m	13-16ft./4.0-5.0m
2	4.6-16ft./1.4-5.0m	9.2-16ft./2.8-5.0m
2.8	3.3-16ft./1.0-5.0m	6.6-16ft./2.0-5.0m
4	2.3-15ft./0.7-4.5m	4.6-16ft./1.4-5.0m
5.6	1.6-11ft./0.5-3.2m	3.3-16ft./1.0-5.0m
8	1.3-7.4ft./0.4-2.3m	2.3-15ft./0.7-4.5m
11	1.3-5.4ft./0.4-1.6m	1.7-11ft./0.5-3.2m

APPENDIX

(Where we put everything that doesn't have its own place in the rest of the manual)

LENS APERTURE AND DEPTH OF FIELD

Depth of field is the area in front of and behind the point on which the lens is focused which will also appear acceptably sharp in the final image. Aperture size, focal length, and subject distance are important factors in determining this range.

Aperture size is commonly expressed as an f-number or f-stop. These are the numbers that are displayed in the data panels and which appear as part of the lens designation. An f-number is inversely related to the actual size of the aperture. For this reason, f/8 is larger than f/11, but smaller than f/5.6.

The whole-stops and half-stops between f/1.4 and f/32 are listed below. Depending on which way you move on the scale, a change of one stop, either from whole-stop to whole-stop or from half-stop to half-stop, will double or halve the amount of light reaching the film, depending on which way you move on the scale.

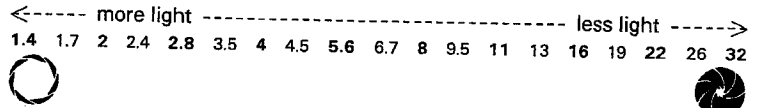

* Whole stops are in bold type.

If focal length and subject distance remain constant, as the size of the lens aperture decreases, depth of field increases. Aperture-priority (A) mode, and manual (M) mode enable you to vary the size of the aperture in order to directly control a picture's depth of field. Different situations usually require different amounts of depth.

— NEXT PAGE —



Large aperture



Small aperture

For example, in a portrait situation, you may want to use a larger aperture in order to focus only on the main subject and separate the person from their background. A small aperture, on the other hand, would be preferable in such cases as landscape photography when you want as much of the scene as possible to appear in focus. Expert Program Selection will automatically set a large aperture in portrait situations so that only your main subject will appear in sharp focus, and a small aperture for landscapes and extreme close-ups to maximize depth of field.

For any given f-number and subject distance, an increase in focal length will reduce the depth of field and a decrease in focal length will have the opposite effect. For example, if a 28-105mm zoom lens is set at 50mm, f/8 and the subject is 12 ft. (4m) away, changing the focal length to 90mm without altering the exposure settings or subject-to-camera distance will noticeably shorten the depth of field. Setting the lens to 28mm, however, extends the range which will appear in focus.

Depth of field also depends on subject distance. Without changing lens aperture or focal length in the above case, if you move to 6 ft. (2m) from your subject, there will be less depth of field in the final image.

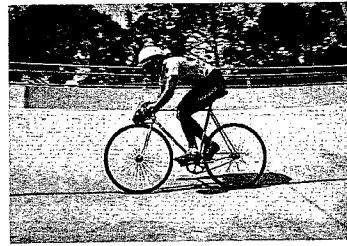

Fast shutter speed

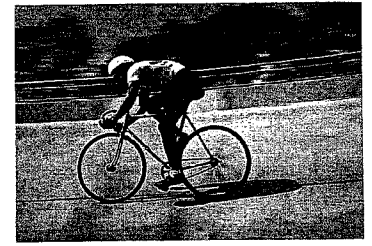

Slow shutter speed

Your choice of shutter speed is an important factor in determining how moving subjects will appear in the final image. Depending on the speed of your subject, slower shutter speeds such as 1/15 sec. will make moving subjects appear blurred and flowing in the picture, creating a greater feeling of motion. Fast shutter speeds, of course, are useful to freeze fast action.

Also, if you are using a telephoto lens, a fast shutter speed can help prevent blurring caused by camera shake. For lenses longer than $f'=50\text{mm}$, a general rule to follow is that $1/f'$ is the slowest usable shutter speed while the camera is being hand-held. For example, if you are using a 135mm lens, try to avoid using shutter speeds slower than 1/180 sec. (the closest shutter speed to 1/135) if you are not using a tripod.

ACCESSORY INFORMATION

If you already have own Minolta accessories, check their compatibility before using them with your 3xi.

1. LENS

All Minolta AF lenses can be used with 3xi. Auto Stand-by Zoom (ASZ) is possible only if the 3xi is used with an xi-series lens. Manual focusing lenses (MD or MC) cannot be attached the 3xi.

Shadowing on the bottom of picture may occur in your pictures when the 3xi's built-in flash is used together with the lens listed below. Before using any of these lenses, check with the nearest Minolta Service facility for the conditions of their use:

AF Zoom xi 35-200mm f/4.5-5.6 AF Zoom 28-85mm f/3.5-4.5
 AF Zoom 28-135mm f/4-4.5

The following lenses cannot be used under any conditions with the 3xi's built-in flash:

AF 300mm f/2.8 APO TELE AF 300mm f/2.8 APO TELE (N)
 AF 600mm f/4 APO TELE AF 600mm f/4 APO TELE (N)

Keep in mind, too, that the built-in flash provided coverage for lenses with focal length no wider than 28mm. The above information applies only to use with the 3xi's flash.

2. FLASH

Minolta i- and xi-series flash units can be used. Flash Shoe Adapter FS-1100 must be used to attach an AF-series flash to 3xi. When used with the 3xi, these units fire whenever a picture is taken, regardless of the exposure mode selected. In all exposure modes TTL flash control will operate.

3. OTHERS

Angle Finder and Magnifier cannot be used.

TROUBLESHOOTING

Problem	Cause	Solution
No display in the data panel when the camera is switched on.	● Battery exhausted	● Install a fresh battery
-- appears in the data panel's aperture display.	● Lens not attached correctly. ● Contacts on camera and/or lens are dirty. ● AZ/MZ switch on an xi-Series lens set to MZ.	● Attach the lens so that it locks in place with a click ● Clean contacts with a clean, dry cloth ● Move the AZ/MZ switch to AZ.
HELP displayed in the body data panel.	● Winding motor problem	● Remove and reinstall the battery.
Autofocus does not work or the lens does not focus when the shutter-release button is pressed.	● Camera set to manual focus. ● AZ/MZ switch on an xi-Series lens set to MZ. ● Subject difficult to autofocus.	● Set the camera to autofocus mode. ● Move the AZ/MZ switch to AZ. ● Focus manually or use focus lock.
Eye-Start does not function.	● Grip sensor is not activated.	● Touch the grip sensor.
Flash fires when shutter-release button is pressed partway down.	● AF illuminator	● Not a problem
In wireless mode, built-in flash fires but off-camera flash does not.	● Off-camera flash set to channel 2.	● Set channel selector switch to CH1.

CARE AND STORAGE

- Always keep your camera in its case with the lens capped when not in use, or with a body cap on when a lens is not attached.
- No part of the camera should be forced at any time.
- 72-exposure cartridge and polaroid instant 35mm films cannot be used.
- Never subject your camera to shock, high heat, humidity, water, or harmful chemicals. Be particularly careful not to leave it in the glove compartment or other places in motor vehicles where it may be subjected to high temperatures.
- Never lubricate any part of the camera body or lens.
- Never touch the shutter curtains, mirror, or the interior of the body or clean them with compressed air. Doing so may impair their alignment and movement.
- External camera surfaces and lens barrel—but not glass surfaces—can be cleaned by wiping with a dry or silicone-treated cloth. Never use organic solvents to clean the camera.
- Never touch the lens or eyepiece surfaces with your fingers. Whisk away loose matter with a blower brush. To remove stubborn spots, use a sheet of photographic lens tissue. If necessary, tissue may be moistened with one drop of lens-cleaning fluid; never place fluid directly on glass surfaces.
- We recommend that you have your camera cleaned once a year at an authorized Minolta service facility.
- If you plan to store your camera for an extended period of time, rewind and remove the film, then remove the battery. Place the camera in a cool, dry place away from dust or chemicals, preferable in an airtight container with a drying agent such as silica gel. Also, it is recommended that you periodically release the camera's shutter to maintain proper working condition.

- This camera is not waterproof, dustproof or sand-proof. If you use this camera near water or at the beach, water-, dust-, or sand-damage may occur. Protect it at all time from moisture or splashes, especially saltwater spray, and be extremely careful to keep sand from both the interior and exterior of the camera and its accessories. If it comes in contact with water, wipe it with a clean, dry cloth and bring it to an authorized Minolta Service facility. If it comes in contact with sand or if sand enters the camera, gently blow away loose particles—**wiping may scratch the camera**—and bring it to an authorized Minolta Service facility.
- If the camera is subjected to a sudden change in temperature, as when transferring it from a cold environment into a heated building, condensation may form inside. To prevent condensation, place the camera in a sealed plastic bag before transferring it from a cold place to a warm environment, and wait for it to come to room temperature before taking it out of the bag.
- After prolonged storage, and especially before taking pictures at an important event, carefully check the operation of the camera and lens.
- The operating range for camera's data panel is from -4 to 122°F (-20 to 50°C). At temperatures outside this range, response time and contrast will change, making the display difficult to read. At very high temperatures, a display may temporarily darken. If this occurs, the display should return when the camera is restored to operating range conditions.
- This camera contains no user-serviceable parts. Do not attempt to disassemble or repair the camera yourself.
- This camera's circuitry may switch off, even when a battery with sufficient power is installed. To resume operation, remove the battery and install it again.

TECHNICAL DETAILS

Type: 35mm SLR with expert control of autofocus (AF), autoexposure (AE), and auto stand-by zoom (ASZ); also auto film transport and built-in flash

Lens mount: Minolta A-type bayonet mount; accepts all Minolta Maxxum AF lenses, xi-Series Autozoom lenses, and AF Power Zoom lens

Eye-Start system: AF, AE, and (if using xi-Series lens) ASZ automatically activated by combination of eyepiece and grip sensors

AF system: Minolta's through-the-lens (TTL) phase-detection system with one wide CCD sensor; activated by Eye-Start; Predictive focus control; range: EV -1 - 18 (at ISO 100)

AF illuminator: Built-in flash automatically fires in low-light and low-contrast to aid focusing

Manual focusing: Visually on Acute-Matte viewfinder screen or by monitoring focus signals in viewfinder

Metering: TTL-type; 8-segment honeycomb-pattern, silicon photo cell (SPC); automatically activated by Eye-Start; second SPC for TTL flash metering of built-in or dedicated accessory flash

AE range: EV 1 - 20 (ISO 100, 50mm f/1.4)

Exposure modes:

Programmed AE: Automatic control of aperture and shutter speed depending on scene characteristics and lens specifications

Aperture-priority AE: Any available aperture selectable in 1/2-stop increments; shutter speed set steplessly from 1/2000 to 30 sec. by auto-exposure program

Shutter-priority AE: Any shutter speed from 1/2000 to 30 sec. selectable in 1-stop increments; aperture set by autoexposure program

Manual: Any shutter speed/aperture combination selectable; shutter speed adjusted in 1-stop increments, aperture adjusted in 1/2-stop increments; BULB also available; correct and over-/under-exposure indicated in viewfinder

Built-in flash: Guide number at ISO 100: 39 in feet, 12 in meters; coverage for 28mm lens; approx. 2 sec. recycle time

TTL flash metering: Operates in all flash modes with dedicated units

Programmed AE: Aperture and shutter speed set automatically; built-in or accessory flash fires automatically when necessary

Shutter-priority AE: Shutter speed and aperture set automatically; flash will fire only if popped-up (built-in flash) or turned on (accessory flash)

Aperture-priority AE: Any available aperture usable; shutter speed automatically set to 1/90 sec.; flash will fire only if popped-up (built-in flash) or turned on (accessory flash)

Manual: Any available shutter speed or aperture usable; flash will fire only if popped-up (built-in flash) or turned on (accessory flash)

Shutter: Electronically-controlled, vertical-traverse, focal-plane type

Automatic control: In program and aperture-priority modes, shutter speed set steplessly between 1/2000 and 30 sec.

Manual control: In shutter-priority and manual mode, shutter speeds selectable from 1/2000 to 30 sec. in 1-stop increments plus BULB in M mode

Auto Stand-by Zoom (ASZ): Programmed selection of focal length based on subject distance; automatically activated by Eye-Start (ASZ available only with xi-Series Autozoom lens)

Film-speed setting: Automatic setting for DX-coded films; ISO 100 set for non-DX-coded films; range: ISO 25-5000 in 1/3-stop increments

Film transport: Auto threading, auto advance to first frame, single frame advance; automatic or manual rewind start; frame counter in data panel

Controls: Program re-set, main switch, focus mode, manual start of rewind, pre-flash, flash-control, aperture-setting, shutter speed/exposure mode, and self-timer

Viewfinder: Eye-level fixed roof mirror showing 90% of field of view; magnification: 0.75X (with 50mm lens at infinity)

Displays:

Viewfinder: Inside screen: etched focus frame; outside screen: LEDs for focus signals, camera-shake/exposure signals, flash signals

Data panel: LCD display with indicators for exposure mode, flash mode, self-timer, frame counter, film-loaded, battery condition, shutter speed display, aperture display, and manual focus

Power: 6-volt 2CR5 lithium battery; automatic battery check when camera is turned on; battery condition displayed by four-stage indicator in data panel; shutter locks when battery is exhausted

Battery Performance: Approximately 60 rolls without flash; 25 rolls with flash on 50% of the exposures (based on Minolta's standard test method, using 24-exposure film)

(Technical Details)

Self-timer: Electronic with approx. 10-sec. delay of shutter release; cancelable; built-in flash or AF illuminator of attached accessory flash fires 3 times before shutter release

Other: Eyepiece cap, film window, carrying strap

Dimensions: 5-3/4 x 3-5/8 x 2-1/2 in. (146.5 x 92 x 64mm)

Weight: 14-13/16 oz. (420g) without lens and battery;

OD model: 15-3/8 oz. (435g)

Specifications and accessories are based on the latest information available at the time of printing and are subject to change at any time without notice.

STATEMENT OF FCC COMPLIANCE

This device complies with Part 15 of the FCC Rules. Operation is subject to the following two conditions: (1) This device may not cause harmful interference, and (2) this device must accept any interference received, including interference that may cause undesired operation. Changes or modifications not approved by the party responsible for compliance could void the user's authority to operate the equipment. This equipment has been tested and found to comply with the limits for a Class B digital device, pursuant to Part 15 of the FCC Rules. These limits are designed to provide reasonable protection against harmful interference in a residential installation. This equipment generates, uses and can radiate radio frequency energy and, if not installed and used in accordance with the instructions, may cause harmful interference to radio communications. However, there is no guarantee that interference will not occur in a particular installation. If this equipment does cause harmful interference to radio or television reception, which can be determined by turning the equipment off and on, the user is encouraged to try to correct the interference by one or more of the following measures:

Reorient or relocated the receiving antenna.

Increase the separation between the equipment and receiver.

Connect the equipment into an outlet on a circuit different from that to which the receiver is connected. Consult the dealer or an experienced radio/TV technician for help.



STATEMENT OF DOC COMPLIANCE

This digital apparatus does not exceed the Class B limits for radio noise emissions from digital apparatus as set out in the Radio Interference Regulations of the Canadian Department of Communications.

QUICK REFERENCE GUIDE

If two operations are marked, do them at the same time. The displays shown should appear after you perform the indicated operation.

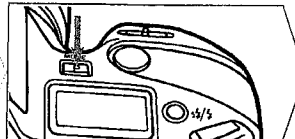
When you want to ...

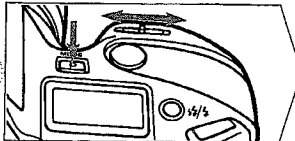
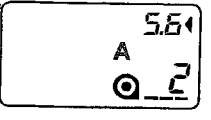
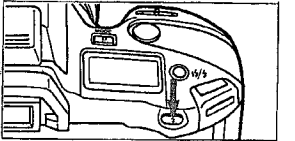
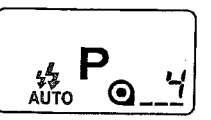
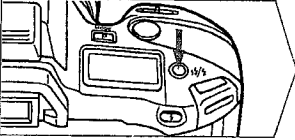
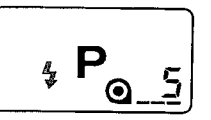
re-set camera to standard settings		
change exposure mode		
pop-up flash		
set/cancel pre-flash		

cancel flash
(in P mode)

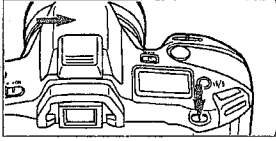

set wireless
flash mode

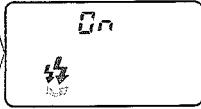
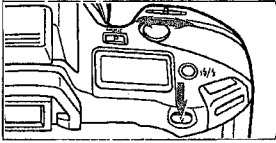

test-fire
(in wireless mode)

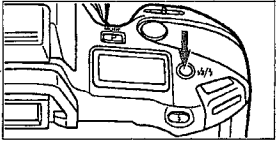

cancel ASZ

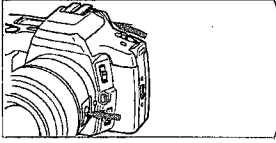

power zoom
(xi-Series or
Power Zoom lens)

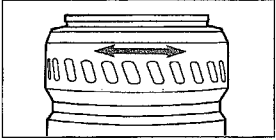

lock focus
(2 methods)

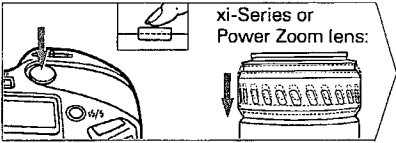

xi-Series or
Power Zoom lens:



manual focus

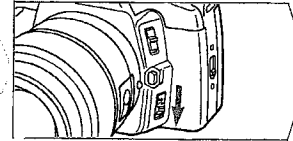

power focus
(xi-Series or
Power Zoom lens)

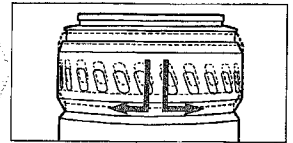

set self-timer

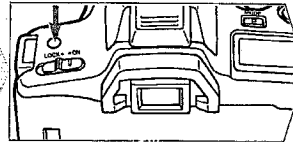

cancel self-timer

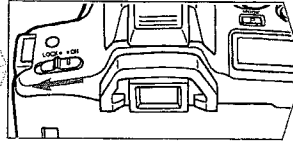

cancel AF
illuminator

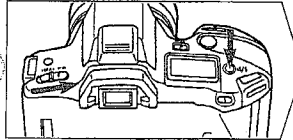

battery check

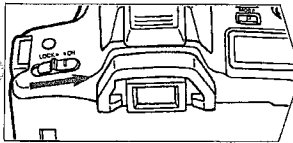

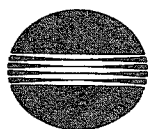

MINOLTA

Minolta Co., Ltd.	3-13, 2-Chome, Azuchi-Machi, Chuo-Ku, Osaka 541, Japan
Minolta GmbH	Kurt-Fischer-Strasse 50, 22923 Ahrensburg, Germany
Minolta France S.A.	365, Route de Saint-Germain, 78420 Carrières-Sur-Seine, France
Minolta (UK) Limited	Rooksley Park, Precedent Drive, Rooksley, Milton Keynes, MK13 8HF, England
Minolta Austria Ges. m.b.H.	Amalienstrasse 59-61, 1131 Wien, Austria
Minolta Camera Benelux B.V.	Zonnebaan 39, P.O. Box 1364 3600 Maarssenbroek, The Netherlands
Belgium Branch	Kontichsesteenweg 38, B-2630 Aartselaar, Belgium
Minolta (Schweiz) AG	Riedstrasse 6 8953 Diefikon, Switzerland
Minolta Svenska AB	Brännkyrkagatan 64, Box 17074, S-10462 Stockholm 17, Sweden
Finland Branch	Niitykatu 6 PL 37 SF-02201 Espoo, Finland
Minolta Portugal Limitada	Av. do Brasil 33 a, 1700 Lisbon, Portugal
Minolta Corporation	
Head Office	101 Williams Drive, Ramsey, New Jersey 07446, U.S.A.
Los Angeles Branch	11150 Hope Street Cypress, CA 90630, U.S.A.
Minolta Canada Inc.	
Head Office	369 Briannia Road East, Mississauga, Ontario L4Z 2H5, Canada
Vancouver Branch	106-3850 Jacobs Road, Richmond, B.C. V6V 1Y6, Canada
Minolta Hong Kong Limited	Room 208, 2/F, Eastern Center, 1065 King's Road, Quarry Bay, Hong Kong
Minolta Singapore (Pte) Ltd.	10, Teban Gardens Crescent, Singapore 2260

© 1991 Minolta Co., Ltd. under the Berne
Convention and Universal Copyright Convention

9222-2085-10

P9410-D409 Printed in Japan