

MINOLTA

MAXXUM[®]
DYNAX[™]

9xi

E INSTRUCTION MANUAL

The "philosophy of camera design" that guided to the development of the Dynax/Maxxum 9xi can be described in three words: Performance, Control, Reliability. This manual is devoted to helping you learn how to control the 9xi and its many features:

- Expert AF with high-speed response, Multi-/Omni-Dimensional Predictive focus control, and 4.5 frames/sec.-sequence shooting with continuous and predictive control
- A top shutter speed of 1/12000 sec. and x-sync speed of 1/300 sec.
- Expert AE's multiple metering modes, Expert Program Selection, and Creative Program Control
- The Quick button, which provides bracketing, multiple exposures, or an immediate, temporary change to one of three pre-selected camera functions
- The metering index

in addition to a host of others. The options which these controls and features provide you, however, are only a small part of *Expert Control*.

As you use the 9xi, you will also discover that *Expert Performance* and *Expert Reliability* play a large part in complementing your own photographic expertise and in raising your skills to a higher level. In short, this means that when you use the 9xi, you can rest assured that you hold in your hands a hardworking, dependable craftsman's tool that will help you deliver superior results for a long time to come.

Performance, Control, Reliability — the 9xi.

IMPORTANT INFORMATION

The Minolta 9xi was designed to work specifically with lenses, flash units, and other accessories manufactured and distributed by Minolta. We therefore caution users of this camera that the attachment and/or use of incompatible products with the 9xi may result in unsatisfactory performance or damage to the camera or its accessories. To obtain optimum performance throughout the life of your 9xi, we recommend that you use only those lenses, flashes and other accessories distributed by Minolta specifically for use with this camera.

STATEMENT OF FCC COMPLIANCE

This device complies with Part 15 of the FCC Rules. Operation is subject to the following two conditions: (1) This device may not cause harmful interference, and (2) this device must accept any interference received, including interference that may cause undesired operation. Changes or modifications not approved by the party responsible for compliance could void the user's authority to operate the equipment. This equipment has been tested and found to comply with the limits for a Class B digital device, pursuant to Part 15 of the FCC Rules. These limits are designed to provide reasonable protection against harmful interference in a residential installation. This equipment generates, uses and can radiate radio frequency energy and, if not installed and used in accordance with the instructions, may cause harmful interference to radio communications. However, there is no guarantee that interference will not occur in a particular installation. If this equipment does cause harmful interference to radio or television reception, which can be determined by turning the equipment off and on, the user is encouraged to try to correct the interference by one or more of the following measures:

Reorient or relocated the receiving antenna.

Increase the separation between the equipment and receiver.

Connect the equipment into an outlet on a circuit different from that to which the receiver is connected. Consult the dealer or an experienced radio/TV technician for help.

STATEMENT OF DOC COMPLIANCE

This digital apparatus does not exceed the Class B limits for radio noise emission from digital apparatus as set out in the Radio Interference Regulations of the Canadian Department of Communications.

TABLE OF CONTENTS

Names of Parts	4	Care and Storage	8
PREPARATION		Diopter Adjustment	
Standard Accessories	11	Film	18
Lens	12	Eye-start	22
Battery	14		
FOCUS		Focus Lock	
Autofocus	24	Special Focusing Situations	29
AF Illuminator	25	Manual Focus	30
Focus Frame	26	Local Focus Area Selection	31
Focus Signals	27		
METERING		Using Spot Metering	
Metering Modes	32	Metering Index	37
Metering Mode Selection	34		
EXPOSURE		M: Manual Exposure	
Exposure Mode Selection	39	Manual Shift	45
P: Programmed Autoexposure	40	Bulb	46
PA/PS: Creative Program Control	41	Exposure Compensation	48
A: Aperture-Priority Autoexposure	42	AE Lock	50
S: Shutter-Priority Autoexposure	43	Exposure Warnings	51
FLASH		Miscellaneous Flash Notes	
Viewfinder Flash Signals	53	Slow-Shutter Sync	55
P-mode Flash and Manual Fill-Flash	53		
A, S, and M-mode Flash	54		
ADDITIONAL FEATURES		SP: Spot-metering selection	
Program-Reset Button	57	AF: Autofocus-area selection	64
Self-Timer	58	Control Dials	65
Film Drive	59	Depth-of-Field Preview	66
Quick Button	60	Panorama Indicators	67
<i>br</i> : Exposure bracketing	61	Focal-Length Display	68
<i>Fb</i> : Flash bracketing	61	Release Priority	69
<i>ME</i> : Multiple exposure	62	Wide-View Mode	70
<i>dr</i> : Drive-mode selection	63		
APPENDIX		Technical Details	
Accessory Information	73		77

NAMES OF PARTS

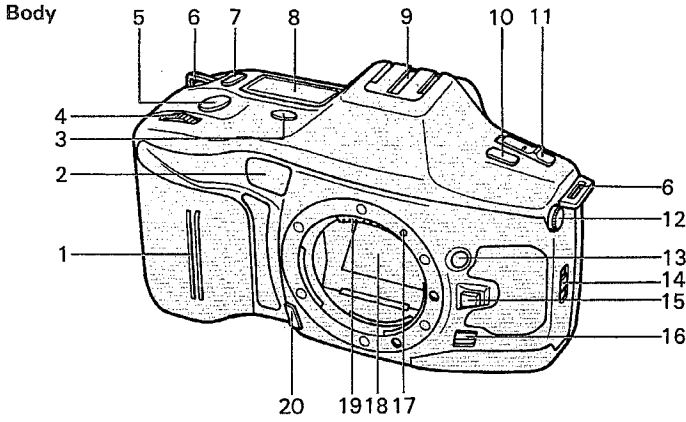

- 1. Grip sensor (22)
- 2. AF illuminator/self-timer light (25/58)
- 3. Wide-view mode button (70)
- 4. Front control dial (65)
- 5. Shutter-release button
- 6. Strap eyelet (11)
- 7. Card on/off button
- 8. Body data panel (6)
- 9. Accessory shoe
- 10. Program-reset button (57)
- 11. Main switch
- 12. PC terminal (54)
- 13. Flash-control button (53)
- 14. Back-cover release (18)
- 15. Lens release (13)
- 16. Focus-mode switch (30)
- 17. Mounting index
- 18. Mirror*
- 19. Lens contacts*
- 20. Depth-of-field preview button (66)

* Do not touch
For information on specific parts, refer to the page numbers shown in parentheses.

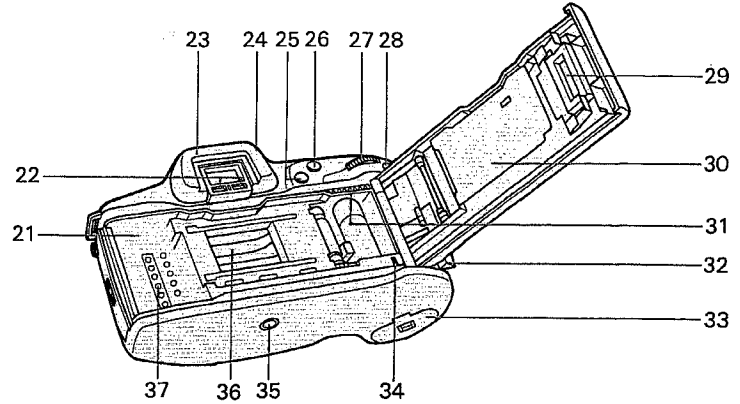

- 21. Film chamber
- 22. Eyepiece sensor (22)
- 23. Eyepiece cup
- 24. Diopter-adjustment dial (17)
- 25. AE-lock button (50)
- 26. Quick button (60)
- 27. Rear control dial (65)
- 28. Function button (65)
- 29. Film window
- 30. Pressure plate*
- 31. Accessory-back contacts*
- 32. Card door
- 33. Battery cover (14)
- 34. Film-leader index (18)
- 35. Tripod socket
- 36. Shutter*
- 37. DX contacts*

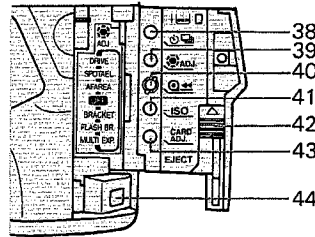

- Inside Card Door**
- 38. Self-timer/drive-mode button (58/59)
 - 39. Quick-adjust button (60)
 - 40. Rewind button (21)
 - 41. ISO button (20)
 - 42. Card-eject slide
 - 43. Card-adjust button
 - 44. Remote-control terminal (47)

Body Data Panel

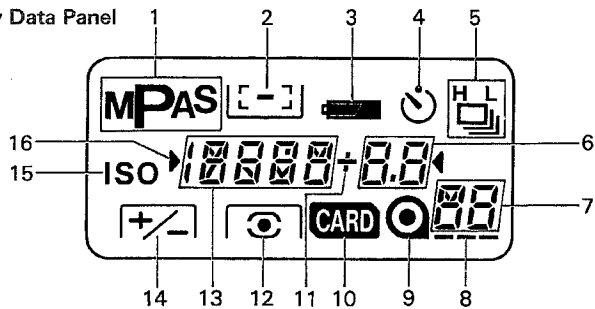

1. Exposure-mode indicators (39)
2. Wide/local-focus indicator (31)
3. Battery-condition indicator (15)
4. Self-timer indicator (58)
5. Drive-mode indicator (59)
6. Aperture/Exposure-compensation/Card-setting display
7. Frame counter/Quick-setting display
8. Film-transport signal (19)
9. Film-cartridge mark (19, 21)
10. Card indicator
11. Exposure-compensation indicator (48)
12. Metering-mode indicator (32)
13. Shutter-speed/Film-speed/Card-name/Local-AF-area display
14. Exposure-compensation reminder (48)
15. Film-speed mark (20)
16. Selectable setting pointers

Viewfinder

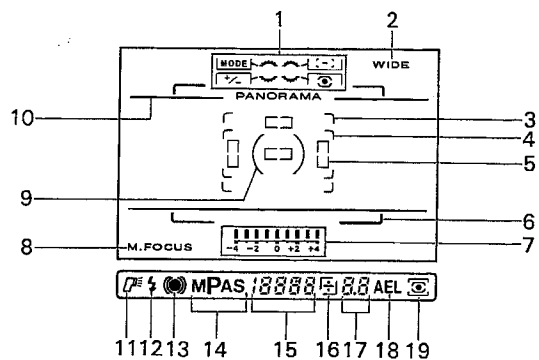

Viewfinder Screen

1. Dial-function indicators (65)
2. Wide-view indicator (70)
3. Horizontal wide-focus frame (26)
4. Vertical wide-focus frame (26)
5. Local-focus areas (31)
6. Film-frame indicators (70) (wide-view mode)
7. Metering index (37)
8. Manual-focus indicator (30)
9. Spot-metering area (35)
10. Panorama indicator (67)

Viewfinder Data Panel

11. Flash-on indicator (53)
12. Flash-ready indicator (53)
13. Focus signals (27)
14. Exposure-mode indicators (39)
15. Shutter-speed/Film-speed display
16. Exposure-compensation indicator (48)
17. Aperture/Exposure-compensation display
18. AE-lock indicator (50)
19. Metering-mode indicator (32)

For information on specific displays and indicators, refer to the page numbers in parentheses.

CARE AND STORAGE

- Always keep your camera in its case with the lens capped when not in use, or with a body cap on when a lens is not attached.
- No part of the camera should be forced at any time.
- 72-exposure cartridges and Polaroid 35mm instant film cannot be used.
- Never subject your camera to shock, high heat, humidity, water, or harmful chemicals. Be particularly careful not to leave it in the glove compartment or other places in motor vehicles where it may be subjected to high temperatures.
- Never lubricate any part of the camera body or lens.
- Never touch the shutter curtains, mirror, or the interior of the body or clean them with compressed air. Doing so may impair their alignment and movement.
- External camera surfaces and the lens barrel—but not glass surfaces—can be cleaned by wiping with a dry or silicon-treated cloth. Never use organic solvents to clean the camera.
- Never touch the lens or eyepiece surfaces with your fingers. Whisk away loose matter with a blower brush. To remove stubborn spots, use a sheet of photographic lens tissue. If necessary, tissue may be moistened with one drop of lens-cleaning fluid; never place fluid directly on glass surfaces.
- We recommend that you have your camera cleaned once a year at an authorized MINOLTA Service Facility.
- If you plan to store your camera for an extended period of time, rewind and remove the film, then remove the battery. Place the camera in a cool, dry place away from dust or chemicals, preferably in an airtight container with a drying agent such as silica gel. Also, it is recommended that you periodically release the camera's shutter to maintain proper working condition.

- This camera is not waterproof, dustproof or sand-proof. If you use this camera near water or at the beach, water-, dust-, or sand-damage may occur. Protect it at all time from moisture or splashes, especially saltwater spray, and be extremely careful to keep sand from both the interior and exterior of the camera and its accessories. If it comes in contact with water, wipe it with a clean, dry cloth and bring it to an authorized MINOLTA Service Facility. If it comes in contact with sand or if sand enters the camera, gently blow away loose particles—**wiping may scratch the camera**—and bring it to an authorized MINOLTA Service Facility.
- If the camera is subjected to a sudden change in temperature, as when transferring it from a cold environment into a heated building, condensation may form inside. To prevent condensation, place the camera in a sealed plastic bag before transferring it from a cold place to a warm environment, and wait for it to come to room temperature before taking it out of the bag.
- After prolonged storage, and especially before taking pictures at an important event, carefully check the operation of the camera and lens.
- The operating range for camera's data panel is from -20 to 50°C (-4 to 122°F). At temperatures outside this range, response time and contrast will change, making the display difficult to read. At very high temperatures, a display may temporarily darken. If this occurs, the display should return when the camera is restored to operating range conditions.
- This camera contains no user-serviceable parts. Do not attempt to disassemble or repair the camera yourself.
- This camera's circuitry may switch off, even when a battery with sufficient power is installed. To resume operation, remove the battery and install it again.
- If *HELP* appears in the body data panel, remove the battery, then re-install it. If it appears again after you release the shutter, take the camera to a MINOLTA Service Facility.

PREPARATIONS

STANDARD ACCESSORIES

Neckstrap

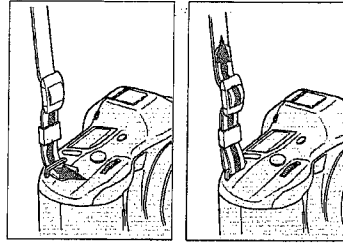

A neckstrap is supplied with your camera. Attach it as shown.

Eyepiece and Accessory Shoe Cap

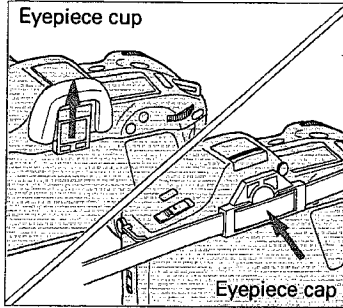

An eyepiece cap is attached to the strap. Remove the eyepiece cup and attach it to the viewfinder eyepiece when you use the self-timer or make long exposures.

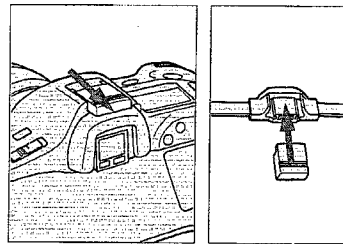

The camera also comes with an accessory-shoe cap which protects the accessory-shoe contacts. When you are using a flash or other accessory, slide the accessory-shoe cap into the eyepiece cap for safekeeping.

LENS

Attaching

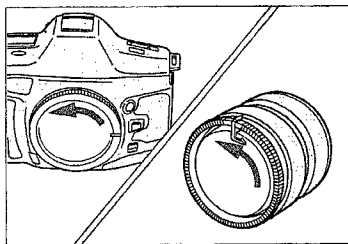

1. Remove the body cap and rear lens cap as shown.

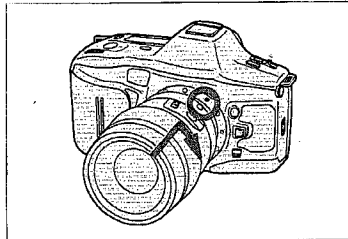

2. Align the red bead on the lens barrel with the red dot on the camera's lens mount. Gently insert the lens into the mount and turn the lens clockwise until it locks in place with a click.

Be careful...

- Do not force the lens onto the body if it does not turn smoothly.
- Never touch anything inside the camera, especially the lens contacts and mirror.

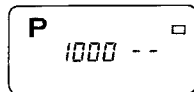

- If no lens is attached to the camera or if the lens is not attached properly, "--" will appear in the body data panel and viewfinder data panels when Eye-Start activates the camera.

Removing

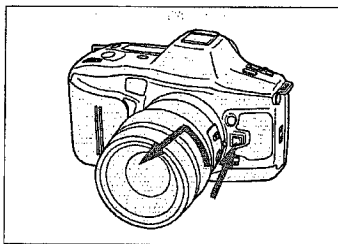

1. While pressing the lens release, turn the lens counterclockwise until it stops. Lift the lens out of the mount.

2. Immediately attach the rear cap to the lens and the body cap or another lens to the camera. This will protect the camera interior, lens contacts, and lens elements.

Care of Glass Surfaces

- Never touch any lens surfaces (including the eyepiece) with your fingers. If a lens surface becomes dirty, first gently clean it with a lens brush. Then, if necessary, moisten a sheet of lens tissue with one drop of lens-cleaning fluid and, starting from the center of the lens, wipe the glass with a circular motion.
- Never lift the mirror or touch its surface, because this may impair the mirror's alignment or scratch its face. Dust on the mirror will not adversely affect meter readings or picture quality. If it is distracting, have the camera cleaned at an authorized Minolta service facility.

BATTERY

The camera uses a 6-volt 2CR5 lithium battery which supplies power for all camera operations. If you are using an xi-Series lens, the camera battery also supplies power to the lens' zoom motor.

Installation

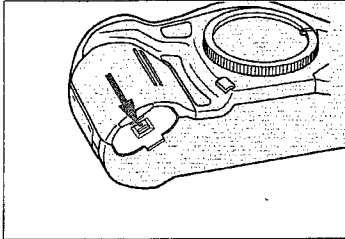

1. Set the main switch to LOCK and slide the battery-cover release in the direction indicated to open the battery cover.

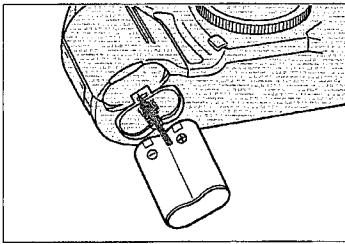

2. Insert the battery according to the marks on the inside of the chamber cover.

3. Snap the cover closed.

• Sometimes it helps ensure good contact to wipe the battery terminals with a clean, dry cloth.

CAUTION

- Read and follow all warnings and instructions supplied by the battery manufacturer.
- Do not attempt to disassemble, recharge, or short-circuit the battery. Do not subject it to high temperatures or fire. The battery may explode and cause severe burns.
- Keep batteries away from small children.

Battery-condition Indicators

Whenever you move the main switch from LOCK to ON, one of the following indicators will appear in the body data panel.

Indicator

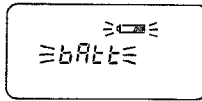
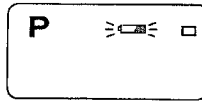
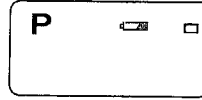
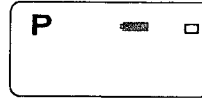

Meaning

1. Full-battery symbol appears for 4 sec. after you turn camera on. **Power is sufficient.**

2. Low-battery symbol appears for 4 sec. after you turn camera on—power is sufficient, but getting low. **Keep a fresh battery handy.**

3. Low-battery symbol blinks while it appears with other operating indicators at any time during use—camera can be operated, but power is extremely low. **We recommend that you change the battery soon.**

4. Blinking low-battery symbol and "bAtte" appears, or no display appears at all and shutter locks—power is insufficient for operation. **Replace the battery or check that the battery is inserted correctly.**

- Indicators 1-3 will not appear while a dedicated, accessory flash is charging.
- Indicator 4 will appear even while the main switch is set to LOCK.

Battery Performance

The 6-volt 2CR5 lithium battery should provide sufficient power for shooting up to 50 rolls of 24-exposure film. These figures are based on Minolta's standard test method using a fresh battery at 68°F (20°C). Actual battery performance will depend on how you use the camera. Also, if you install a new battery that has been in prolonged storage, battery performance may vary.

Cold-Weather Operation

Lithium batteries provide excellent performance in cold weather. However, if you plan to shoot many rolls of film in temperatures near or below 32°F (0°C), we recommend that you carry the camera inside your coat while you are not shooting to keep it warm. You may also want to carry several spare batteries in your pocket so that you can change the camera battery if necessary. Do not discard a cold battery. After it warms up, it will regain some of its charge.

DIOPTER ADJUSTMENT

Use the diopter-adjustment dial to adjust the viewfinder eyepiece between -2.5 and +0.5 power. For additional correction, attach an Eyepiece Corrector 1000.

To adjust:



1. Focus on a subject, preferably one that is not moving.

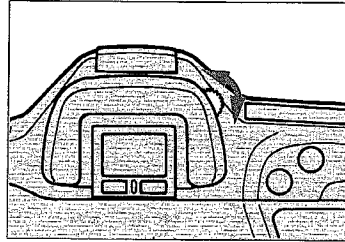

2. Turn the diopter-adjustment dial until the subject's image in the viewfinder screen appears sharpest.

FILM

Loading Film

Before you load film, always check the body data panel. If the film cartridge is displayed, do not open the back cover. See page 21 for instructions on re-winding a partially exposed roll of film.

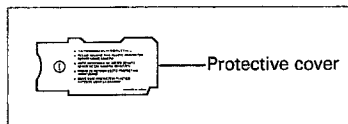

- Before you load film for the first time, remove and discard the protective cover in the film gate.
- Always load film in subdued or shaded light to limit the chances of fogging your film.

1. Open the back cover by sliding the back-cover release downward.

2. Place the film cartridge into the film chamber and extend the leader between the guide rails to the film-leader index. Make sure the sprocket holes in the film's lower edge are engaged by the camera's sprocket teeth.

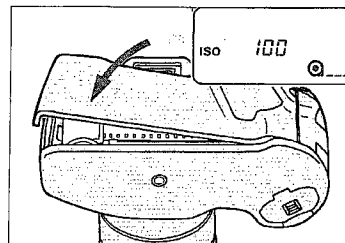
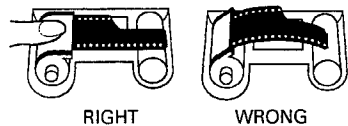
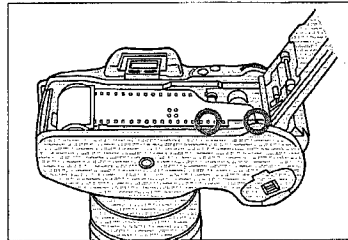
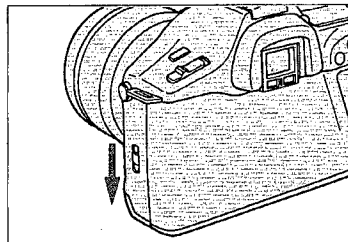

3. Close the back cover and move the main switch to **ON**. The camera will automatically advance the film to the first frame and **1** will appear in the film counter.

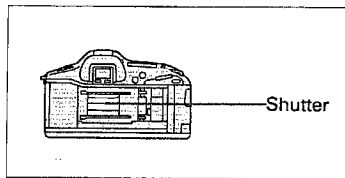

• **NEVER TOUCH THE SHUTTER CURTAIN WITH YOUR FINGERS OR WITH THE FILM TIP.** Its precision design makes it extremely sensitive to pressure.

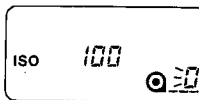

• If the film is loaded incorrectly, **0** will blink in the frame counter and the shutter will remain locked. Open the back cover and repeat steps 2 and 3.

• Make sure the film leader is shaped correctly, otherwise the film may not advance properly. Trim a torn or bent film tip so that it looks like the correct one pictured at left.

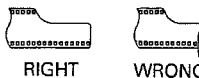

• If the film tip extends beyond the red mark, gently push the excess film back into the cartridge.

• If you move the main switch to **ON** before you load film, do not touch the grip sensor during the above procedures.

Automatic Film Speed Setting

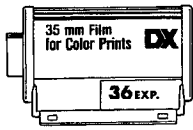

If you use DX-coded film, the camera will automatically set the correct film speed. The film speed setting will be displayed in the body data panel for 4 sec. after you load the film. To display the film speed to which the camera is set at any time, press the ISO button in the card door—the film speed will appear in the body data panel.

Manual Film Speed Setting

If you are using a non-DX-coded film or if you want to override the camera's automatic setting, you must manually set the film speed. The camera will initially set non-DX-coded film to the ISO of the previous roll.

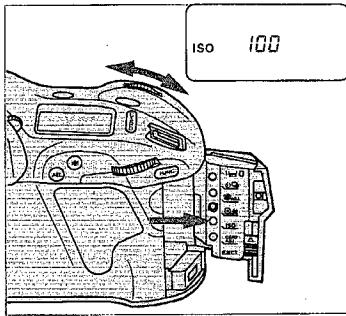

1. Load the film, open the card door and press the ISO button.
2. Turn the front control dial until the desired film speed setting appears in the body data panel.
3. Press the ISO button again to enter your selection and return to operating mode, or wait 4 sec. and the setting will be entered automatically.

- Each click of the dials will change the film speed setting by 1/3-stop between ISO 6 and 6400.
- For flash exposures, Minolta recommends that you use film between ISO 25 and 1000.

Automatic Rewind

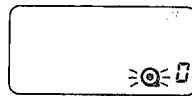

After you have exposed the last frame, the camera will automatically rewind the film. With a fresh battery, it takes about 6 seconds to rewind a 36-exposure roll, or 5 seconds for a 24-exposure roll. When the film has been completely rewound, the motor will stop and the film-cartridge symbol in the body data panel will blink to indicate that it is safe to open the back cover.

Manual/Silent Rewind

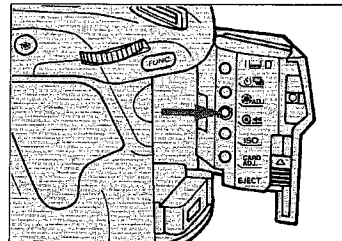

If you manually activate the camera's rewind motor, it will rewind the film silently. To begin film rewind manually, open the card door and press the rewind button. It will take approximately 10 seconds to rewind a 36-exposure roll or 8 seconds to rewind a 24-exposure roll.

- When the motor stops and the cartridge mark in the body data panel blinks, it is safe to open the back cover.
- If the motor stops before the film is completely rewound, insert a fresh battery. Do not open the back until the film cartridge mark blinks in the body data panel.

EYE-START

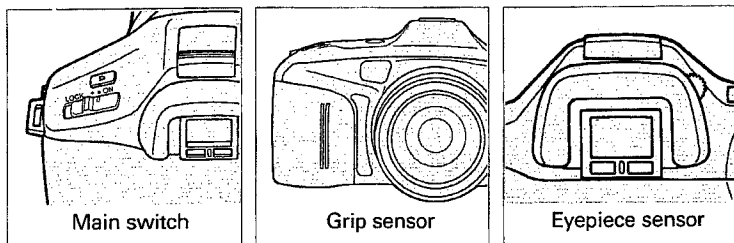

The Eye-start System automatically activates all of the 9xi's main systems as soon as you bring the camera to your eye. When you move the camera's main switch to **ON**, the body data panel and the grip sensor activate. Touching the grip sensor then activates an infrared emitter/detector located beneath the eyepiece. When the eyepiece sensor detects an object near the viewfinder, autofocus and autoexposure immediately activate so that the camera is already operating by the time you frame your main subject.

- If Eye-start does not function, you can activate the camera by pressing the shutter release partway down.
- When the eyepiece sensor no longer detects an object near the viewfinder, autofocus and autoexposure will automatically switch off.
- If you break contact with the grip sensor while you are looking through the viewfinder, autofocus and autoexposure will switch off four seconds later.
- If you are wearing sunglasses which absorb infrared light, Eye-start may not function.

FOCUS

AUTOFOCUS

When you look through the viewfinder and place your subject in the focus frame, the autofocus system automatically:

- Adjusts the focus frame for vertical or horizontal camera orientation.
- Determines which AF sensor is detecting the main subject.
- Activates continuous AF and maintains focus on moving subjects.
- Calculates where a moving subject will be at the time the shutter opens and sets focus to this point while the mirror swings up.

The 9xi also has focus-priority shutter release which prevents the shutter from releasing until the subject is in focus. This ensures a high percentage of sharp images when you are photographing a moving subject with continuous film advance. Release priority mode is also available. In it, continuous autofocus and predictive focus control will continue to function, but sharp focus is not required for the shutter to release. See page 69 for details.

AF ILLUMINATOR

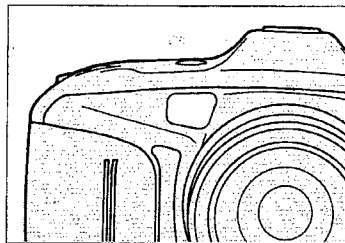

The 9xi's AF system operates in light levels as low as -1 EV (at ISO 100). In low light or when the contrast of your main subject is too low to be read by the autofocus sensors, the AF illuminator will automatically activate. It projects a pattern of lines onto your subject which the AF sensors can then detect.

- Be careful not to obstruct the AF illuminator while you are holding the camera.
- The range of the AF illuminator is 0.7 - 9m.
- The AF illuminator will not work if the focal length of the lens you are using is 300mm or longer (excluding AF Zoom/AF Zoom xi 100-300 and AF Zoom 75-300) or if you are using the 3X-1X Macro Zoom.

FOCUS FRAME

Fig. 1

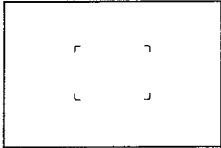

Fig. 2

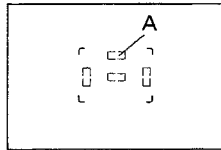
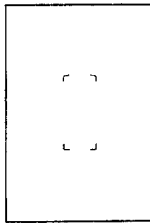

Fig. 3



The 9xi's ultra-wide focus area (fig. 1) provides you with a great deal of flexibility in composing your photographs and makes it easy to follow and maintain focus on fast-moving subjects. When you photograph, place your main subject somewhere in this frame and, when the green focus indicator lights to confirm that focus has been achieved (see Focus Signals, p.27), press the shutter-release button completely down to take the picture.

The ultra-wide focus area contains four autofocus sensors (fig. 2). When the camera's Expert AF system is activated, it will first determine which of the sensors is reading the main subject. When you press the shutter-release button partway down, if the subject is stationary focus will lock.

Sensor A in figure 2 will be used to focus on your subject's eyes when you take portraits with the camera held horizontally. When you turn the camera to take vertical pictures, this sensor will be switched off and the brackets which outline the focus frame will change to show the new frame (fig. 3).

You can also manually select any one of the AF sensors either full-time (Local Focus Area Selection, p.31) or temporarily (Quick Button p.60).

FOCUS SIGNALS



When the camera is activated, either by Eye-start or by pressing the shutter-release button partway down, the AF system begins evaluating the scene to determine the location of your subject within the frame. One of the following focus signals will appear in the viewfinder data panel:

	Continuous AF; focus is confirmed
	Stationary subject; focus is locked*
	Focus cannot be confirmed

* This only appears after you press and hold the shutter-release button partway down.

- None of the above indicators will appear while the lens is focusing.
- In autofocus mode, if focus cannot be confirmed, the shutter will lock unless you select release priority (p.69).

FOCUS LOCK

If, as a result of the composition or framing you have chosen, a stationary subject falls outside the focus area, first lock focus on it then recompose the scene as desired.



1. Place your subject in the center of the focus area.

2. Press the shutter-release button partway down.



3. Wait for the focus signal to change from (●) to (●) in the viewfinder data panel, recompose the image, and take the picture.

● Focus will remain locked if, after the shutter releases, you only let the shutter-release button partway-up and take another picture.

- With an xi-Series lens, you can also lock focus by pulling the lens control ring toward the camera or pressing the lens function button.
- When the camera is set to honeycomb-pattern metering, exposure and focus will be locked at the same time.
- When the metering mode is set to center-weighted average or spot, the exposure will not be locked with autofocus. You must use the AE lock button separately.

SPECIAL FOCUSING SITUATIONS

The camera's autofocus system will produce sharply focused pictures in almost any situation. In the cases described below, however, it may be difficult or impossible for the camera to correctly focus on your subject—you may have to use focus lock (p.28) or manual focus (p.30).

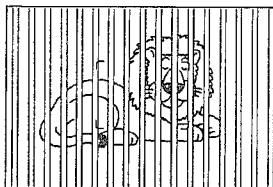

If two subjects at different distances overlap within the focusing frame.

- Photographing through windows should not be a problem unless they are very dirty or a window frame or other object passes through the focus frame.

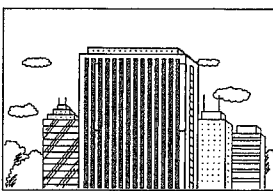

If a subject composed of alternating light and dark lines completely fills the focusing frame.

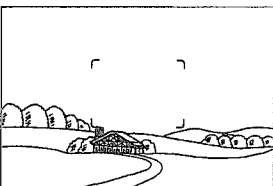

On very bright, very dark, or low-contrast subjects.

MANUAL FOCUS

To manually focus the lens:

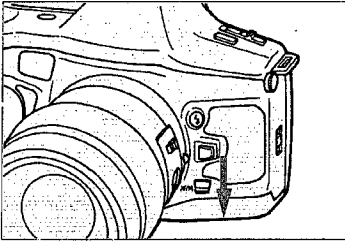

1. Slide the focus-mode switch down to set the camera to manual focus mode—**M. FOCUS** will appear in the viewfinder.

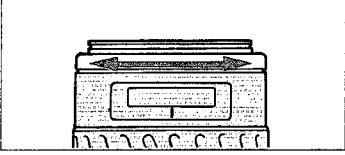

2. If you are using an AF-series lens, turn the focusing ring until the subject appears sharp. With an xi-Series lens or AF power zoom lens, pull and turn the control ring. For more information, refer to the lens manual.

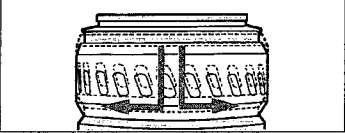

- Whenever any of the four AF sensors (three, if you are holding the camera vertically) detects a focused image, the green focus-lock signal will light.
- In manual focus mode, the shutter will release even if the subject is not in focus.
- To return to autofocus mode, slide the focus-mode switch down or press the program re-set button (p.57).

LOCAL FOCUS AREA SELECTION

If you want to use a specific AF sensor, you can manually override the selection sequence and use only one of the four sensors.

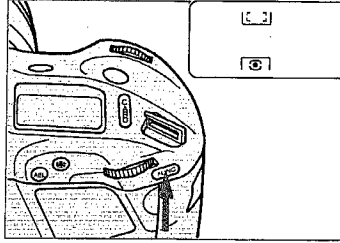

1. Press the function button twice.
 -  will appear in the viewfinder.

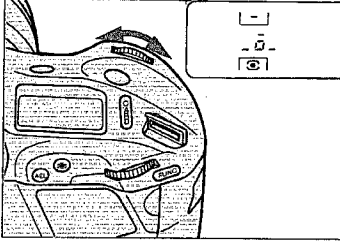

2. Turn the front control dial until the AF sensor you want appears in the viewfinder screen or body data panel.

3. Press the shutter-release button partway down to enter the area you have chosen and return to normal operating mode.



- Autofocus will not function while you are selecting a local AF area.
- You can also set the Quick button to make a temporary, pre-programmed change in the AF sensor the camera is using (see Quick Button, p.60).

METERING

METERING MODES

The 9xi has three metering modes: 14-segment honeycomb-pattern metering (☉), center-weighted average metering (☉), and spot metering (•). The camera's metering cell is divided into 13 honeycomb-pattern segments plus a background segment. These are used both singly and in various combinations to provide the necessary metering pattern and weighting.

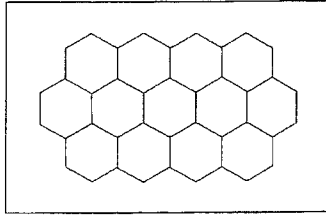

14-segment honeycomb pattern metering

Fourteen-Segment Honeycomb-Pattern metering is the camera's standard metering mode and will be set whenever you press the program re-set button (p.57). This mode uses information from the autofocus system to set the metering pattern based on the position of the main subject in the frame. The camera then evaluates each of the honeycomb segments separately to determine the degree of spotlighting or backlighting present in your scene and selects the shutter speed and aperture accordingly.

In center-weighted average mode, the exposure is based on an average of the readings made by each of the honeycomb segments, with emphasis placed on the center of the image. Take care when photographing backlit, spotlight, or off-center subjects as the meter may include non-subject areas of your scene in the exposure calculation. To correct or prevent this, use exposure compensation (p.48) or AE lock (p.50).

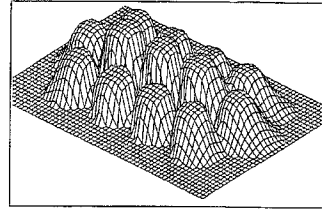

center-weighted average metering

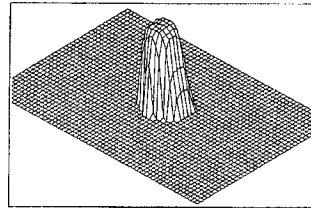

spot metering

Spot metering uses only the center segment of the honeycomb pattern to read the brightness of the subject inside the viewfinder's spot-metering area. Use this mode when you want to measure only a specific part of your scene or subject (see Using Spot Metering, p.35).

METERING MODE SELECTION

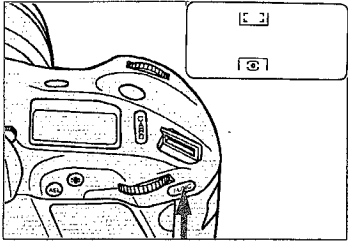

1. Press the function button twice.
 -  will appear in the viewfinder screen.

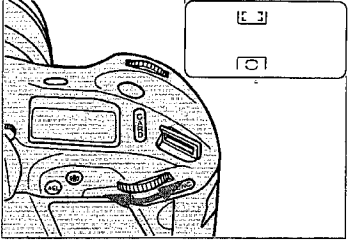

2. Turn the rear control dial to select the metering mode you want.
3. Press the shutter-release button partway down to enter your selection.

- ☉ 14-segment honeycomb-pattern metering
- Center-weighted average metering
- Spot metering

USING SPOT METERING



1. Center the spot-metering area in the viewfinder over the area of your scene or subject that you want to meter.

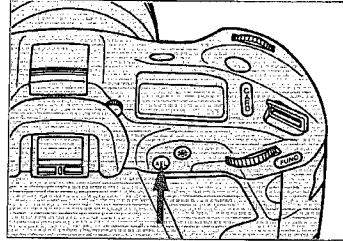

2. Press and hold the AE lock button.



- The metering index will appear in the viewfinder.

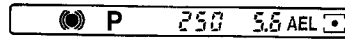

— NEXT PAGE —

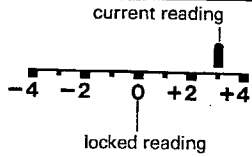

• In manual exposure (M) mode, the metering index will always appear and will display the difference between your exposure settings and those suggested by the camera's meter.

3. Recompose the scene as desired.
 - The pointer on the metering index will indicate the difference between the locked exposure and the exposure required by the subject currently inside the spot area (See p.37). You can use this to make a quick comparison of highlight and shadow areas.
4. Press the shutter-release button all the way down to take the picture.

METERING INDEX

The table below summarizes the four situations in which the metering index will appear.

	When the Index Appears	0 Position on Index	Pointer
P / A / S	14-Segment Honeycomb-Pattern metering is selected and the function button is pressed once (p.49)	Exposure calculated by center-weighted average metering	Current exposure settings*
	Center-weighted average metering is selected and exposure compensation is being added (p.49)	Un-biased center-weighted average reading	Amount of compensation
	In spot mode and the AE lock button is pressed and held (p.35)	Locked spot reading	Difference in exposure required by area currently inside the spot circle
	In manual exposure mode (p.45)	Exposure calculated by camera using current metering mode	Difference in exposure provided by manual camera settings

*This will include any exposure compensation you have set manually in addition to the adjustment made by honeycomb-pattern metering for backlit, spotlight, or off-center subjects.

+1.5 EV

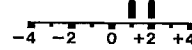

• When two pointers appear, the indicated value is between them.

• The pointer will blink if the indicated value is greater than +4 EV or less than -4 EV.

EXPOSURE

EXPOSURE MODE SELECTION

The 9xi has four exposure modes: programmed, aperture-priority, and shutter-priority autoexposure, as well as manual exposure.

To change the exposure mode:

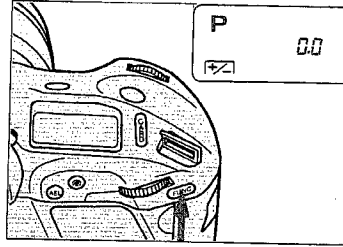

1. Press the function button once.
● $\frac{\text{MODE}}{\square}$ will appear in the viewfinder.

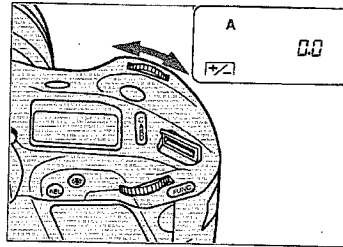

2. Turn the front control dial until the exposure mode you want appears in the body or the viewfinder data panel.

3. Press the shutter-release button partway down to enter the exposure mode you have chosen.

P mode is designed to be the camera's most versatile and flexible exposure mode. This mode will be set automatically when you press the program-reset button and it is ideally suited for almost all situations. Expert Program Selection analyzes subject size, motion, and magnification as well as lens focal length, and it then sets both the shutter speed and aperture according to the requirements of the scene.

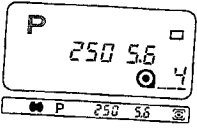

There is no single program line for each focal length, and no special modes to set manually for different situations. Instead, for each light level there is a range of possible aperture and shutter speed combinations from which Expert AE selects the optimum exposure settings each time you press the shutter-release button.

If, while the camera is set to P mode, you would like to use a shutter speed or aperture other than the one Expert Program Selection has chosen, you can do so by using Creative Program Control (PA and Ps modes). See the following section for details.

• If the aperture and shutter speed displays blink, then the required exposure settings are beyond the range of the camera and/or lens (see Exposure Warnings, p.51).

PA/Ps: CREATIVE PROGRAM CONTROL

When the camera is set to P mode, you can change the shutter speed or aperture set by Expert Program Selection by turning the front or rear control dials. The front dial controls the shutter-speed setting and the rear dial the aperture. Either setting will change in 1/2-stop increments and the camera will automatically adjust the other to maintain a correct exposure.

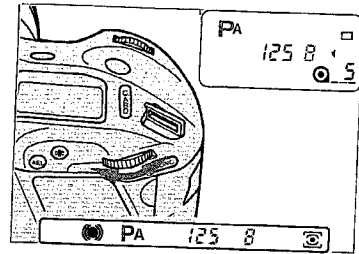

PA

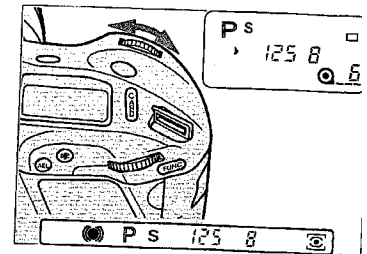

Ps

- Creative Program Control will operate only if the grip and eyepiece sensors are activated.
- In PA mode, if the shutter-speed display blinks, a correct exposure is not possible with the aperture you have selected. Similarly, if the aperture display blinks in Ps mode, a correct automatic setting is not possible (see Exposure Warnings, p.51).
- To cancel PA or Ps, turn the camera off and on once or press the program reset button.
- An attached accessory flash will not fire while the camera is in Ps or PA mode. Similarly, Creative Program Control will not work if an accessory flash is attached to the camera and the flash-on indicator **FL** appears in the viewfinder data panel.

A: APERTURE-PRIORITY AUTOEXPOSURE

In **A** mode, you select the aperture you want and the camera's Expert AE system automatically sets a shutter speed which will provide a correct exposure. This mode is especially useful when you want control over depth of field while retaining the minimum necessary autoexposure control.

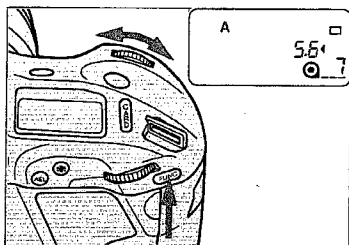

1. Refer to Changing Exposure Modes (p.39) and select **A**.

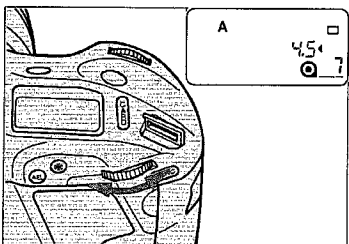

2. Compose your scene and turn the rear control dial to select the aperture you want.

3. Press the shutter-release down completely to take the picture.

- The shutter-speed display in the viewfinder and body data panels will blink if the required shutter speed is beyond the camera's range (see Exposure Warnings, p.51).
- If the metering-mode indicator blinks, the lighting is beyond the camera's metering range (see Exposure Warnings, p.51).

S: SHUTTER-PRIORITY AUTOEXPOSURE

This exposure mode allows you to select the shutter speed you want and the camera's Expert AE system sets the aperture which will provide a correct exposure. Use **S** mode when you want full control over shutter speed settings and the resulting motion effects in your pictures while retaining the speed and convenience of autoexposure control.

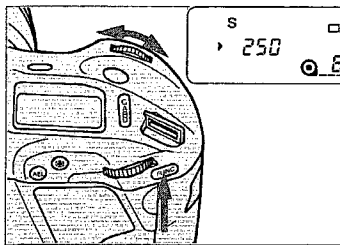

1. Refer to Changing Exposure Modes (p.39) and select **S**.

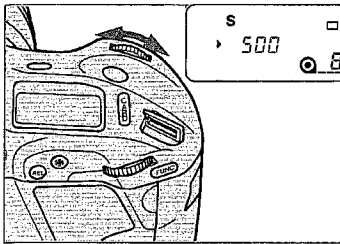

2. Compose your scene and turn the front control dial to select the shutter speed you want.

3. Press the shutter-release button down completely to take the picture.

- The aperture display in the viewfinder and body data panels will blink when the required aperture is beyond the range of your lens (see Exposure Warnings, p.51).
- If the metering-mode indicator blinks, the light level is beyond the camera's metering range (see Exposure Warnings, p.51).
- You cannot select **BULB** in **S** mode (see Bulb, p.46).

M: MANUAL EXPOSURE

Use manual mode whenever you want full control over the exposure settings. In this mode, you select the shutter speed and aperture and the metering index will tell you whether your settings will provide an over-, under-, or correctly-exposed picture.

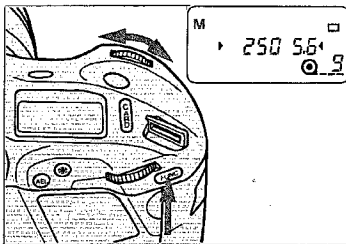

1. Refer to Changing Exposure Mode (p.39) and select M.

- The metering index will appear in the bottom of the viewfinder screen.

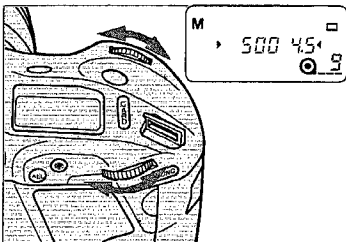

2. Turn the front dial to change the shutter speed and the rear dial to change the aperture.

- The shutter speed and aperture displays in the viewfinder and body data panels will change in 1/2-stop increments.

3. Press the shutter-release button completely down to take the picture.

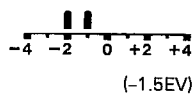

In manual mode, the metering index will show you how the exposure you have set compares with the camera's meter reading. The 0 position on the index represents the camera's suggested exposure using the metering method you have selected. The pointer indicates your settings in relation to this reading.

- If the metering-mode indicator blinks, the light level is beyond the camera's metering range (see Exposure Warnings, p.51).

Manual Shift

Manual shift enables you to quickly change both the aperture and shutter-speed settings without changing the exposure you have selected.

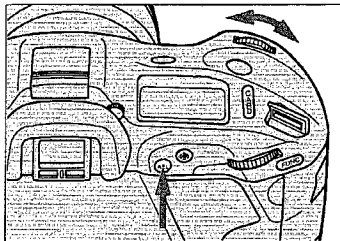

Press and hold the AE lock button while you turn the front control dial. The aperture and shutter-speed settings will change in 1/2-stop increments.

BULB



When you select BULB, the shutter will remain open as long as you press the shutter-release button. Use it to make long exposures.

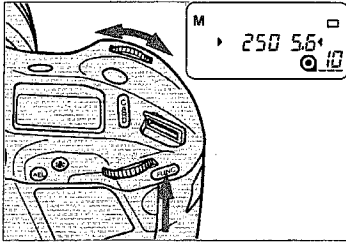

1. Mount the camera on a tripod.
2. Set the exposure mode to manual (M).

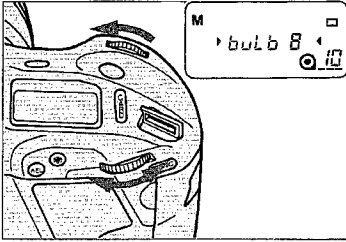

3. Turn the front control dial to the left until *bulb* appears in the body and viewfinder data panels. Turn the rear dial to set the aperture.

4. Compose your scene and focus the lens.

● If the scene is too dark, autofocus may not function. Slide the focus mode switch down and focus the lens manually.

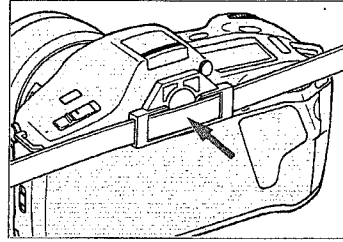

5. Attach the eyepiece cap (see p.11).

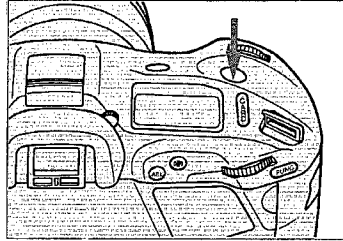

6. To take the picture, press and hold the shutter-release button. The shutter will remain open until you release the button.

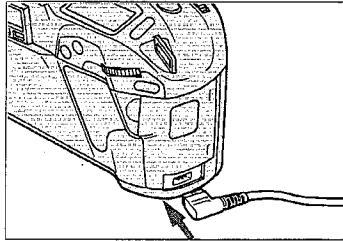



● To reduce or prevent blurring of your picture due to camera shake, attach Remote Cord RC-1000 S or L. Open the card door, remove the remote-control terminal cover, and insert the remote cord's plug into the terminal. The shutter will remain open as long as you hold the remote control button down.

EXPOSURE COMPENSATION

This function enables you to bias the camera's exposure calculation up to 4 stops over or under the normally metered settings.

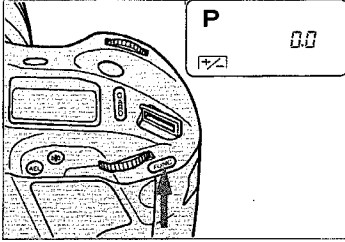
To set a compensation factor:



1. Press the function button once.
 -  and, if spot metering is not selected, the metering index will appear in the viewfinder.

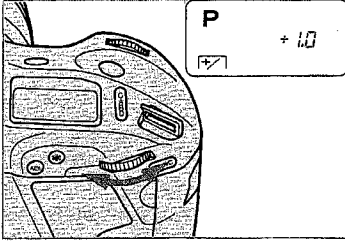

2. Turn the rear control dial until the compensation factor you want appears in the viewfinder and body data panels.

3. Press the shutter-release button partway down to enter the exposure factor and return to normal operating mode.

• After you enter the compensation factor, the number and the metering index will disappear, but the exposure reminder will remain. To check the amount of compensation at any time, press the function button once.

• In 14-segment honeycomb-pattern metering mode the position of the pointer will be determined by any exposure adjustment which the camera has made automatically to correctly expose the main subject in addition to any compensation which you set manually. When center-weighted average metering is selected, the pointer will show only the compensation which you set (see Metering Index, p.37).

Honeycomb-pattern metering selected

Current exposure settings (+1.5EV)
(including manual exposure compensation)



Exposure determined by
center-weighted average metering

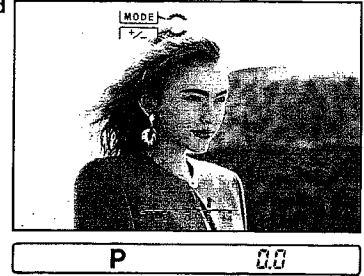

Center-weighted average metering selected

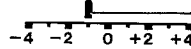

Manual exposure compensation (-1EV)

To cancel exposure compensation, set 0.0 or press the program re-set button (p.57).

AE LOCK

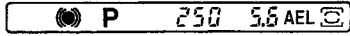
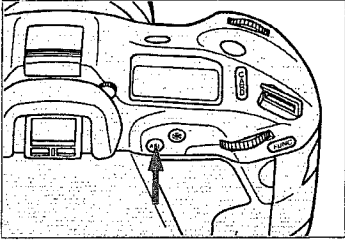

To lock the exposure settings without locking focus, position your subject in the viewfinder and press the AE lock button. Hold the button in, recompose, and take the picture.

- Exposure lock should be used with center-weighted average metering if the main subject is centered but strongly backlit or spotlighted, or if it is off-center and darker or brighter than the center of the frame. Approach and position the subject so that it fills most of the viewfinder frame, press and hold the AE lock button, and recompose the image.

Also, in spot-metering mode, the AE lock button will lock a spot reading (Using Spot Metering, p.35).

- The exposure will remain locked if, after you take the picture, you continue to press the AE lock button.

- In **P** and **S** modes, you can change the aperture/shutter-speed combination without changing the exposure by turning the front control dial while you press the AE lock button.

EXPOSURE WARNINGS

The following warnings will appear when the camera has difficulty measuring the scene brightness or selecting the required exposure settings. Blue marks around a display indicate that it is blinking.

	Display	Cause	Action
P / A / S / M		Scene or subject brightness is beyond the camera's metering range.	In low light, select M mode and use a hand-held meter, use faster film, or increase the brightness of your surroundings. In bright light, attach a neutral-density (ND) filter, use slower film, or reduce the overall brightness of your surroundings.
P		Light level is beyond the range of available shutter speeds and apertures.	
PA / A		Required shutter speed beyond the range of the camera.	Turn the rear control dial until the display stops blinking.
Ps / S		Required aperture beyond the range of the lens.	Turn the front control dial until the display stops blinking.

FLASH

FLASH

Viewfinder Flash Signals

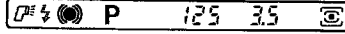
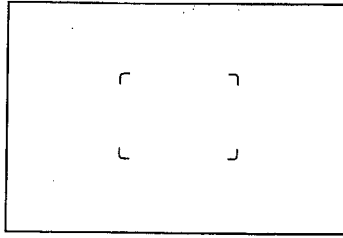

When a dedicated Maxxum/Program flash is attached to the 9xi's accessory shoe and the camera's meter detects that flash is required, the flash-on indicator P^f will appear in the viewfinder data panel. When the flash is charged, the flash-ready indicator ⚡ will light. After you take the picture, if the flash output was sufficient to provide a correct exposure, the flash-ready indicator will blink.

P-Mode Flash and Manual Fill-Flash

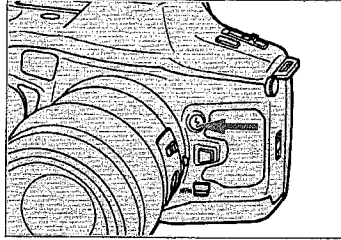

In **P** mode, the flash will fire automatically whenever necessary. You can also manually force the flash to provide fill-light at any time in **P** mode by pressing the flash-control button while you take the picture.

- The flash will not fire if you are using Creative Program Control (**PA** and **Ps** modes).

A, S, and M Mode Flash

In **A**, **S**, and **M** modes, the flash will only fire if you first turn it on. Then, when charging is complete, it will fire every time you take a picture. If the flash is off, it will not fire. Camera operation in these three exposure modes with flash is the same as without flash except you cannot use shutter speeds faster than the camera's top x-sync speed, 1/300 second.

- 1/300 second can be selected either manually or automatically, only if a dedicated accessory flash is attached to the camera and the flash is turned on. If you select 1/300 sec., it will be changed to 1/250 sec. when you turn off or remove the flash.

Miscellaneous Flash Notes

- The camera's threaded PC terminal accepts PC-type sync cords from non-dedicated flash units or flash units that do not have a hot-shoe contact. When you connect a sync cord to the PC terminal, set the shutter speed to 1/250 sec. or slower. The terminal's cap can be stored in the eyepiece cap as shown.
- Certain Studio Flash Systems operate on a Negative Polarity triggering system. (See Below)

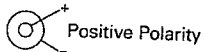
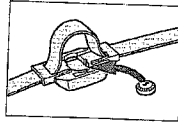

Positive Polarity



Negative Polarity

It is possible that when using a system of this nature in conjunction with the 9xi the flash may not fire.

It is therefore recommended that before using a Studio Flash system of this nature you contact a Minolta Authorised Service facility for advice.

- To use wireless/remote off-camera flash control, you must have either:
 1. Two or more xi-Series flash units, at least one of which must be a 5400xi. The other may be either a 5400xi or a 3500xi. Refer to the 5400xi's instruction manual for details.

or:

2. Wireless Remote Flash Controller and one or more xi-Series flash units (5400xi and/or 3500xi). Refer to the Controller's instruction manual for details.

Slow-Shutter Sync



With slow-shutter sync



Without slow-shutter sync

When you select slow-shutter sync, the camera will set a slower shutter speed to increase the background exposure in a flash picture. Flash output will be decreased automatically to maintain a correct exposure on your subject. This helps to add some of your subject's surroundings, such as bright lights, to a picture which would otherwise have only black background.

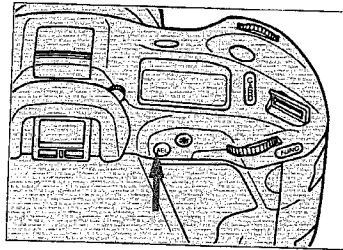

To use slow-shutter sync, press and hold the AE lock button while you take the picture.

- If the background is bright or a large aperture is set, the shutter speed may not be reduced.
- The flash-ready indicator in the viewfinder data panel will blink if the flash output was sufficient to provide a correct exposure.

ADDITIONAL FEATURES

PROGRAM-RESET BUTTON

When you press the program-reset button, the following camera functions will return to their program settings.

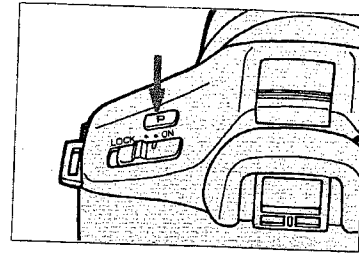

Function	Program Setting	Page
Focus mode	Autofocus	30
Focus area	Wide	31
Metering mode	14-segment honeycomb-pattern	32
Exposure mode	P mode	39
Exposure compensation	+/-0.0	48
Flash (when attached)	Auto on	See flash manual
Film-drive mode	Single-frame advance	59
Self-timer	canceled	58
Wide-view mode	canceled	70

- If you have a dedicated, accessory flash attached to the 9xi, pressing the program-reset button will also return it to its own program settings. Refer to the flash owner's manual for details.
- Many of the above program settings may be changed with the Customized Function Card xi, available separately.

SELF-TIMER

The electronic self-timer will delay release of the shutter for approximately 10 sec. after you press the shutter-release button.

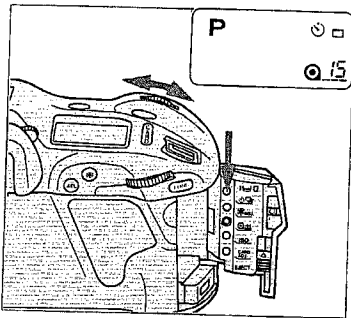

To activate the self-timer:



1. Open the card door and press the self-timer/drive-mode button.
2. Turn the front control dial until the self-timer indicator appears in the body data panel.
3. Press the self-timer/drive-mode button again to enter your selection.
4. Compose your scene and press the shutter-release button all the way down to start the timer.

- If you are not looking through the viewfinder when you press the shutter-release button, light entering the eyepiece may affect the camera's automatic exposure settings. To prevent this, attach the eyepiece cap before you start the timer (see p.11).
- The AF illuminator will blink twice per second until the shutter releases.
- To stop the self-timer during countdown, move the main switch to LOCK. To restart the timer, move the main switch back to ON and press the shutter-release button again. To cancel the self-timer, press the program re-set button.
- The self-timer is canceled automatically after shutter-release.

FILM DRIVE

The camera has three film-drive modes. In single-frame mode, the camera makes one exposure and advances the film one frame each time you press the shutter-release button. In high-speed continuous mode (), the film is advanced at up to 4.5 frames per second while you hold the shutter-release button down; low-speed continuous mode (), will provide approximately 2 frames per second. When you use either low- or high-speed continuous and autofocus mode, focus will be checked and adjusted between each exposure to ensure that moving subjects remain sharply focused.

To change the film-drive mode:

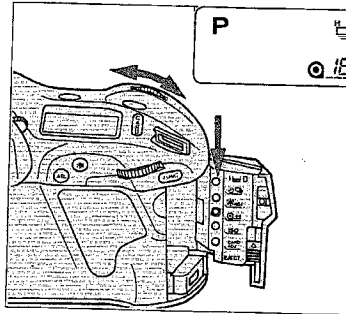

1. Open the card door and press the self-timer/drive-mode button.
2. Turn the front control dial until the indicator for the mode you want appears in the body data panel.
3. Press the self-timer/drive-mode button again to enter the mode you selected.

- To return to single-frame advance, repeat the steps above, turning the front dial so that  appears in the data panel.
- Because the camera has focus-priority shutter release, the actual frame rate will depend on the speed of your main subject. To ensure the maximum speed of the drive mode you select, you can use release-priority mode. See page 69 for details.

QUICK BUTTON

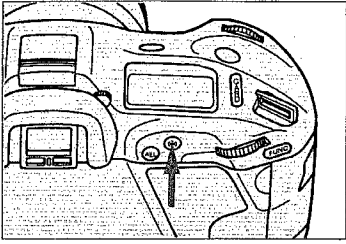

The Quick button is a flexible-function button which you can program to provide one of three temporary changes to the camera's operation as well as three additional functions.

To change the function of the Quick button:

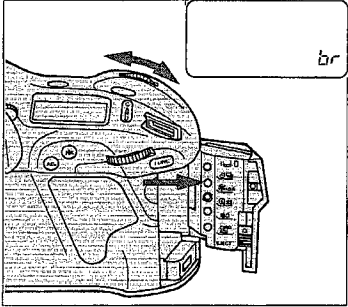

1. Open the card door and press the Quick-adjust button.

2. Turn the front control dial until the function indicator you want appears in the frame counter.

br: Exposure bracketing
Fb: Flash bracketing
ME: Multiple exposure
dr: Drive-mode select
SP: Spot select
RF: Autofocus-area select
--: Off

3. Press the Quick-adjust button again to enter your selection.

- If you select "off", the Quick button will have no function and, when you press it, -- will appear in the body data panel.
- You can check the setting of the Quick button at any time by pressing the Quick-adjust button. One of the above indicators will appear in the film-frame counter.

- When you press the program re-set button, the function of the Quick button will not change.
- The Quick button's function will be limited when you use some Creative Expansion Cards. Refer to the chart on page 74 before you use the Quick button with any card.

br: Exposure bracketing



With this setting you can expose a series of 3 frames with a 1/2-stop change between exposures. The order of the exposures will be 1/2-stop under metered exposure, metered exposure, and 1/2-stop over metered exposure. To make an exposure-bracketing series, press and hold the quick button while you press the shutter-release button. Hold the shutter-release button and Quick button down until the series is complete. Releasing either the shutter-release or the Quick button will cancel the series. The film will stop automatically after three frames have been exposed.

- The film will advance in high-speed continuous mode and the exposure settings will change automatically.
- Focus and metering are locked on the first frame of the series.
- Flash cannot be used.

Fb: Flash bracketing

With a dedicated Maxxum/Program flash attached to the 9xi, this function enables you to automatically shoot a 3-frame flash-bracketing series. The order of exposures in the series will be: 1/2-stop under metered exposure, metered exposure, and 1/2-stop over metered exposure.

To use flash bracketing, wait for the flash-ready indicator to appear in the viewfinder data panel, then press and hold the Quick button while you take the first picture. Wait for the flash-ready indicator to reappear before you take each picture. The following displays will appear during the series (Frame numbers 18-20 exposed in the example.):

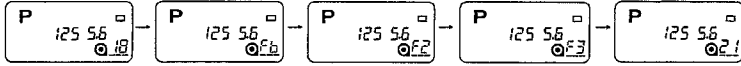

- You do not have to press the Quick button before every frame—only the first.
- To cancel the flash bracketing during the series, press the Quick-adjust button.
- If a flash is not attached to the camera, **On FL** will blink in the body data panel when you press the Quick button and the shutter will lock.

ME: Multiple exposure

When you make this selection, you can take an unlimited number of exposures on the same frame. Pressing and holding the quick button while you press the shutter-release button will prevent the film from advancing each time.

Example: 2 exposures

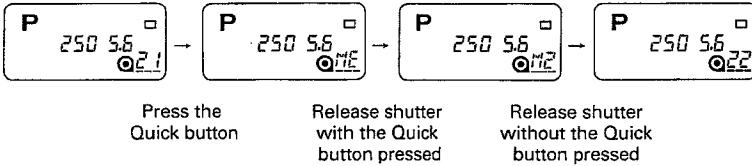

- If you press the shutter-release button without holding the quick button, the film will advance after the exposure is made.
- To advance the film without making an exposure, press the Quick-adjust button.

The camera will make the full, metered exposure each time you press the shutter-release button. If your subject's images overlap or if the background is not dark, some manual exposure compensation may be necessary. Suggested compensation for 2-9 exposures is listed below:

Number of Exposures	2	3	4	5	6	7	8	9
Exposure Compensation (EV)	-1	-1 1/2	-2	-2 1/3	-2 1/2	-2 2/3	-3	-3 1/3

Exposure can be adjusted in 1/2-EV using the camera's exposure-compensation function (p.48) or in 1/3-EV by changing the film-speed setting (p.20). The above figures are intended to be a starting point. Some experimentation may be necessary to produce the results you want.

dr: Drive-mode selection

The action of the Quick button depends on the drive mode you have already set.

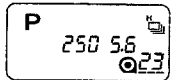

Initial Camera Setting	With Quick Button Pressed
Single-frame advance	High-speed continuous
Low-speed continuous	Single-frame advance
High-speed continuous	Single-frame advance

- The change will remain active only as long as you hold the Quick button in.
- Self-timer cannot be used.

SP: Spot-metering selection

If you have selected 14-segment honeycomb-pattern metering or center-weighted average metering, pressing the Quick button when you have selected this setting will temporarily activate spot metering and lock the exposure. If spot metering is already active, pressing the Quick button will lock the exposure settings.

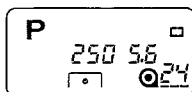

- Flash cannot be used while spot metering is active.

AF: Autofocus-area selection

The action of the Quick button in this mode depends on the camera's settings:

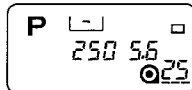

Initial Camera Setting	With Quick Button Pressed
Wide focus area	Center focus area*
Any local focus area	Wide focus area

* If you turn the front dial while you are pressing the Quick button, you can select any of the local focus areas.

- The change will remain active only as long as you are pressing the Quick button.

CONTROL DIALS

The table below summarizes the action of the control dials together with the function button.

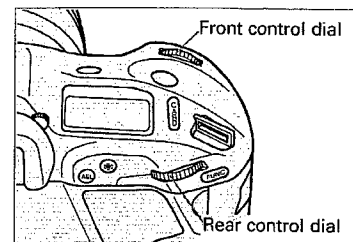

Function Button	Front Control Dial	Rear Control Dial
Not pressed	Shutter speed (in Ps, S, and M modes)	Aperture (in PA, A, and M modes)
Pressed once	Exposure mode	Exposure compensation
Pressed twice	Local/wide AF areas	Metering mode

DEPTH-OF FIELD PREVIEW

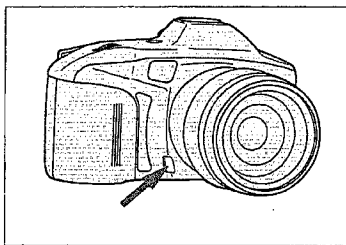
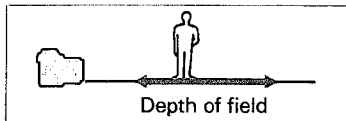

Depth of field is the distance in front of and behind the point on which the lens is focused which will also appear sharp in the final image. To check how much of your scene will appear in focus, press the depth-of-field preview button. This will stop the lens down to the aperture which appears in the data panel. The image in the viewfinder screen will darken when you press the button; the smaller the aperture, the darker it will be.

- When you press the depth-of-field-preview button, exposure and focus will lock. It is possible to release the shutter while pressing the depth-of-field preview button.
- The exposure settings cannot be changed while you are pressing the depth-of-field preview button.
- In wide-view mode, depth-of-field preview functions only while you are holding the shutter-release button partway down (see *Wide-View Mode*, p.70).
- A shadow may appear in the center of the viewfinder screen while the depth-of-field preview button is pressed, especially if you are using telephoto lenses at a small aperture. This will not appear on the final image.

PANORAMA INDICATOR

When you insert the Panorama Adapter in the back of the camera, the panorama indicators will automatically appear in the viewfinder screen. If you do not insert the adapter, but want to compose your pictures with the intent of creating panoramic images later, you can manually display the panorama indicators to aid you in composition.



Panorama Adapter

To turn the indicator on:

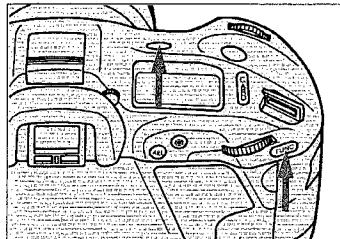

Press and hold the function button while you press the wide-view button.

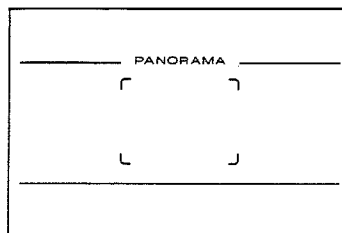

- After you take a picture, the panorama indicator will disappear.
- Exposed film and printed pictures will be full-frame, not panoramic.

FOCAL-LENGTH DISPLAY

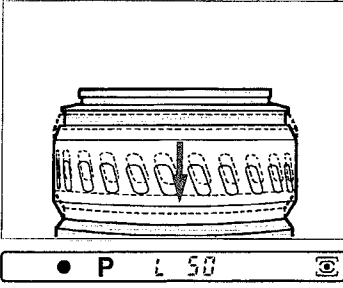

When you use an xi-Series zoom lens, pulling the lens control ring towards the camera body will display the current focal length in the viewfinder data panel. After this, if you zoom the lens, the focal-length display will change. It will remain displayed for four seconds after you release the control ring.

- If the AZ/MZ switch is set to MZ, the focal length will not appear.

RELEASE PRIORITY

The 9xi has focus-priority shutter release. With it, the shutter will not release if the subject is not in focus and the camera is in autofocus mode. This helps ensure a high percentage of sharp photographs when you are shooting a moving subject and using high-speed drive. This also makes the actual speed of film advance dependent on the speed of your subject.

In release-priority mode, the shutter will release even if the subject is not sharply focused. Continuous autofocus and predictive focus control will continue to operate, but when photographing moving subjects with continuous drive, priority will be placed on maintaining the top speed of the drive mode you have selected.

Each 9xi, when it is manufactured, will be set to focus-priority mode. To select release-priority mode:

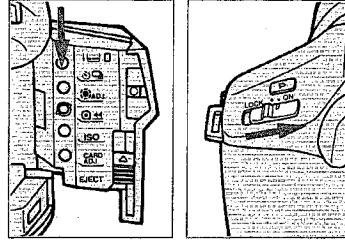

1. Open the card door.
2. Press and hold the self-timer/drive-mode button while you slide the main switch from LOCK to ON.

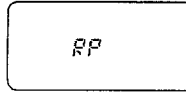

- "RP" will appear in the body data panel when you first set release priority and every time you turn the main switch on while it is set.



- When you set release priority, the performance of multi-/omni-dimensional predictive focus control may diminish slightly.

To return to focus-priority mode, repeat 1 and 2 above.
• "AFP" will appear in the body data panel.

WIDE-VIEW MODE

With an xi-Series zoom lens, you can view 150% of the actual image area up until the moment you press the shutter-release button.

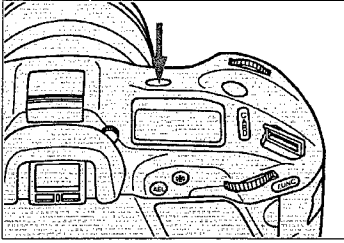

1. Press the wide-view-mode button.

- The camera will automatically set a shorter focal length to give you a wider field of view.

- Both WIDE and the film-frame indicators will appear in the viewfinder.



2. Compose your picture inside the film-frame indicators.



3. Press the shutter-release button partway down.

- The lens will zoom to fill the viewfinder with the image inside the film-frame indicators.

4. Press the shutter-release button down completely to take the picture.

- The usable focal length range of the lens will be reduced slightly while you are using wide-view mode. Although the lens will zoom to its shortest focal length while wide-view is activated, the view inside the film-frame marks will never be wider than 1.5 times (150% of) its shortest setting. Also the lens will only zoom to 2/3 its longest focal length while wide-view mode is active so that it will be able to restore the image when you press the shutter-release button.

For example, with a 28 - 105mm lens:

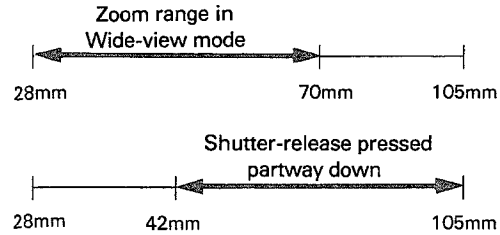

- If you press the wide-view mode button with the lens set anywhere between the shortest focal length and 1.5 times the shortest focal length (28 - 42mm in the example), the camera will enter wide-view mode, but, in this case, the image inside the film-frame marks will not be the same as the original angle of view.

APPENDIX

ACCESSORY INFORMATION

If you already have own MINOLTA accessories, check their compatibility before using them with your 9xi.

1. LENS

- All Minolta AF lenses can be used with 9xi. Wide-view mode is possible only if the 9xi is used with an xi-Series lens.
- Manual focusing lenses (MD or MC) cannot be attached to the 9xi.
- If you are using the 9xi with an xi-Series lens, it is possible to take pictures with the lens' AZ/MZ switch set to MZ. However, power zoom and wide-view mode will not operate. Refer to "USE WITH NON-xi CAMERA BODIES" in the lens manual for instructions on manual zooming.
- When "--" appears in the aperture display of the body data panel (eg., when a lens is not attached), the shutter will lock if film is in the camera to prevent accidental exposures. If you want to release shutter under such conditions (eg., when the camera is attached to a telescope), contact your nearest authorized MINOLTA Service Facility.

2. FLASH

- All Minolta i- and xi-Series flash units can be used.
- Flash Shoe Adapter FS-1100 must be used to attach an AF-series flash (Program/Maxxum Flash 4000AF, 2800AF, 1800AF, 1200AF Macro) to your 9xi. When used with the 9xi, these units fire whenever a picture is taken, regardless of the exposure mode selected. In all exposure modes TTL flash control will operate. If you set exposure bracketing or metering-mode selection to the quick button, turn the flash off. If you set flash bracketing, turn the flash on. Otherwise, "OFF FL" or "On FL", respectively, will blink in the body data panel and picture cannot be taken.
- X-Series flashes cannot be used.

3. CARDS

	With 9xi	Additional restrictions with Quick button					
		br	Fb	ME	dr	SP	AF
Travel	1,2	0	0	0	0	0	0
Child	0	16	0	0	0	0	0
Sports action	0	0	0	0	0	0	0
Sports action 2	0	16	0	0	0	0	0
Portrait	0	0	0	0	0	0	0
Automatic depth control	2	0	17	0	0	0	0
Closeup	0	0	0	0	0	0	0
Panning	3	-	-	0	0	0	0
Intervalometer	0	-	-	18	0	0	0
Background priority	4	0	-	0	0	0	0
Multiple exposure	5,6	-	-	19	0	0	0
Exposure bracketing	5,7	-	-	0	-	0	0
Flash bracketing	5,8	-	-	0	-	-	0
Bracketing 2	8	-	-	0	-	0	0
Data memory	5,9	0	0	20	0	0	0
Data memory 2	0	0	0	20	0	0	0
Fantasy effect	10	-	-	0	0	0	0
Fantasy 2	11	-	-	0	0	0	0
Automatic program shift	5,12	-	-	0	-	0	0
Auto shift 2	0	-	-	0	-	0	0
Multi spot memory	13,14	0	-	0	0	21	0
Highlight/shadow control	13	22	-	22	22	21	22
A/S mode	X	X	X	X	X	X	X
Customized function xi	15	0	0	0	0	0	0
Customized function	X	X	X	X	X	X	X

O: can be used.

X: cannot be used.

-: cannot be used. Card function overrides the Quick button. "Card" blinks in the body data panel.

1 to 22: can be used with the conditions listed below.

1. ASZ does not function with 9xi.
2. In release priority, the shutter will not release unless the subject is in focus. Continuous film drive is not recommended.
3. Metering index can be used to monitor your panning skill. If the indicator is to the + side of the index, tracking is smooth.
4. Metering index can be used to select the background sharpness. If the indicator is to the + side of the index, both near and far objects should appear sharp in the final image.
5. Settings must be made with front control dial.
6. The shutter speed will always be adjusted if a 9xi is being used without flash during fade-in/fade-out in M mode.
7. The shutter speed of a 9xi will always be adjusted when bracketing in M mode.
8. With flash bracketing, exposure adjustment and frame number for the next frame will appear in the body data panel when you take the 9xi away from your eye.
9. Shutter speed of 1/300 sec. will be stored as 1/250 sec. and 1/12000 sec. will be stored as 1/8000 sec.
10. Focus priority is recommended. If you use release priority, make sure that the subject is in focus before you release the shutter. Otherwise, the fantasy effect may not be obtained. Continuous film drive is not recommended.
11. In release priority, the shutter will not release unless the subject is in focus.
12. The starting point of the exposure series cannot be changed from the settings chosen by Expert Program Selection.
13. When you insert this card, spot metering is automatically activated. Use the AE lock button instead of the spot-metering button as stated in the card's instruction manual.
14. Number of areas measured will appear in the body data panel when you take the 9xi away from your eye.
15. When you select metering method in personal program mode, select either honeycomb-pattern or center-weighted average metering.
16. APZ does not function during bracketing series.

17. Not recommended; flash bracketing may not function if the picture is overexposed.
18. The entire intervalometer sequence will be exposed on one frame, but the film will not advance automatically. Press the Quick-adjust button to advance to the next frame.
19. Pictures can be taken but the frame counter will not function.
20. Only the last exposure on the frame will be stored in the card.
21. You can control the camera with either the AE lock button or Quick button.
22. Press both AE lock button and Quick button at once.

4. OTHER

- Control Grip CG-1000 and Data Receiver DR-1000 cannot be used with 9xi.

TECHNICAL DESCRIPTION

AF system: Minolta's through-the-lens (TTL) phase-detection system with four CCD sensors; activated by Eye-start; Multi-dimensional predictive focus control; built-in AF illuminator automatically activated in low-light/low-contrast conditions; AF sensitivity range: EV -1 to 19 (at ISO 100); AF illuminator range: 0.7 to 9m (Based on Minolta's standard test methods)

Metering: TTL-type; 14-segment honeycomb-pattern silicon photocell (SPC); automatically activated by Eye-start; second SPC for TTL flash metering of dedicated flash unit; range: honeycomb-pattern EV 0-20, center-weighted average EV 0-20, spot EV 3-20 (ISO 100, 50mm f/1.4 lens)

Shutter: Electronically-controlled, vertical-traverse, focal-plane type; automatic speeds: in P and A modes, stepless 1/12000 to 30 sec. with nearest half-stop displayed; manual speeds: in S and M modes, 1/12000 to 30 sec. in 1/2-stop increments plus BULB in M mode; x-sync shutter speed: 1/300 sec.; x-sync shutter speed in wireless/remote flash mode: 1/60 sec.(1/30 sec. in ratio)

Viewfinder: Eye-level fixed pentaprism showing 92% of vertical and 94% of horizontal field of view; magnification: 0.75X with 50mm lens at infinity; transparent LCD screen and Acute-Matte screen; diopter: -2.5 to +0.5 adjustable; long eye-relief

Focusing screen: Changeable at an authorized Minolta Service facility; type L (matte field with grid) or type S (matte field with vertical/horizontal scales)

Film-speed range: Automatic range: ISO 25-5000 in 1/3-stop increments; manual range: ISO 6-6400 in 1/3-stop increments

Power: 6-volt 2CR5 lithium battery

Battery performance: Approximately 50 rolls (based on Minolta's standard test method, using 24-exposure rolls)

Dimensions: 6-7/16 x 3-7/8 x 2-1/2 in. (163 x 98.5 x 64mm)

Weight: 1 lb. 10-1/8 oz. (740g) without lens and battery

Quartz Data Back model: 1 lb. 10-5/8 (755g) without lens and battery

Specifications and accessories are based on the latest information available at the time of printing and are subject to change without notice.

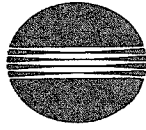

MINOLTA

Minolta Camera Co., Ltd.	3-13, 2-Chome, Azuchi-Machi, Chuo-Ku, Osaka 541, Japan
Minolta GmbH	Kurt-Fischer-Strasse 50, D-2070 Ahrensburg, Germany
Minolta France S.A.	365-367 Route de Saint-Germain, 78420 Carrières-Sur-Seine, France
Minolta (UK) Limited	1-3 Tanners Drive, Blakelands North, Milton Keynes, MK14 5BU, England
Minolta Austria Gesellschaft m.b.H.	Amalienstrasse 59-61, 1131 Wien, Austria
Minolta Camera Benelux B.V.	Zonnebaan 39, 3606 CH Maarssenbroek, P.B. 264, 3600 AG Maarssen, The Netherlands
Belgium Branch	Kontichsesteenweg 38, B-2630 Aartselaar, Belgium
Minolta (Schweiz) AG	Riedhof V, Riedstrasse 6 8953 Dietikon-Zürich, Switzerland
Minolta Svenska AB	Brännkyrkagatan 64, Box 17074, S-10462 Stockholm 17, Sweden
Finland Branch	Niittykatu 6 PL 37 SF-02201 ESPOO, Finland
Minolta Portugal Limitada	Av. do Brasil 33 a, 1700 Lisbon, Portugal
Minolta Corporation	
Head Office	101 Williams Drive, Ramsey, New Jersey 07446, U.S.A.
Los Angeles Branch	11150 Hope Street Cypress, CA 90630, U.S.A.
Chicago Branch	3000 Tollview Drive, Rolling Meadows, IL 60008, U.S.A.
Minolta Canada Inc.	
Head Office	369 Britannia Road East, Mississauga, Ontario L4Z 2H5, Canada
Vancouver Branch	106-3850 Jacombs Road, Richmond, B.C. V6V 1Y6, Canada
Minolta Hong Kong Limited	Room 208, 2/F, Eastern Center, 1065 King's Road, Quarry Bay, Hong Kong
Minolta Singapore (Pte) Ltd.	10, Teban Gardens Crescent, Singapore 2260

© 1992 Minolta Camera Co., Ltd. under the Berne
Convention and Universal Copyright Convention

9222-2081-11

P9304-B7 Printed in Japan